

February 2004

# AGRICULTURE HERBICIDE STUDY MANUAL

---



OREGON DEPARTMENT OF AGRICULTURE

Pesticides Division  
635 Capitol Street NE  
Salem, Oregon 97301-2532  
(503) 986-4635

## Table of Contents

<u>Chapter</u>		<u>Page</u>
1	Weeds .....	1
2	Adjuvants for Herbicide Sprays .....	9
3	Herbicide Formulations .....	15
4	Ten Important Herbicide Families .....	25
5	Factors Influencing Foliage-Applied Herbicides .....	45
6	Factors Influencing Soil-Applied Herbicides .....	51
7	Application Equipment .....	59
8	Calibration .....	81
9	The Label .....	87
10	Avoiding Chemical Trespass .....	103
11	Management Aspects of Herbicide Use .....	107
12	Glossary .....	113
	Appendix .....	121
	Common names and trade names	
	Answers to Study Questions	



## PREFACE

This manual is designed to be used to prepare potential pesticide licensees for the Agriculture-Herbicide examination, although it may also be helpful to persons preparing for the Pesticide Consultant Examination and other examinations dealing with vegetation control. At the end of each chapter are a number of study questions. After reading the chapter, the reader should test his/her understanding of the material by working through the study questions. If the reader is uncertain about the answer to any study question, referring back to the text is the preferred method. In addition, abbreviated answers are given in the back of the manual. Those should be used only as a last resort, because they are too brief for a full understanding of the concept. Reviewing the appropriate section in the chapter is preferable.

The examination for the Agriculture-Herbicide examination will consist of 100 questions. Weed identification is not covered in this manual. The applicant will need to obtain access to a weed identification book in order to learn to identify certain weeds (see Chapter 1 -- Study Questions). Anyone who can answer and understand the study questions should have little difficulty passing the exam.

Some of the chapters in this manual deal with the "whys," not just the "hows". Having applicators educated, not just trained, in their area of work is considered desirable. Certainly knowing why herbicides translocate better at one growth stage than another is not required for following the label and applying the herbicide at the

correct time, but understanding the background makes the applicator a more skillful professional and upgrades the reputation of the individual and the profession.

Trade-name products are mentioned only as examples; this does not imply endorsement of these products or discrimination against unmentioned products by the Environmental Protection Agency, Oregon Department of Agriculture, or Oregon State University. Herbicides named in this manual are cross-listed in the Appendix under common and trade names.

Certain sections of the book are taken with permission from "Applying Pesticides Correctly", the Oregon State Department of Agriculture Core Manual, and "Weed Control--Text Supplement" of the Oregon State University Department of Crop and Soil Science. These contributions are acknowledged.

This manual was made possible by a grant from the Environmental Protection Agency to the Oregon Department of Agriculture, Plant Division. The manual was compiled and edited by:

Dr. Arnold P. Appleby  
Professor Emeritus of Crop Science  
Department of Crop and Soil Science  
Oregon State University  
Corvallis, OR 97331-3002

October, 1992



## CHAPTER 1 WEEDS

A weed can be defined as "a plant growing where some human doesn't want it". This puts the classification of a plant as a weed into a human decision process, and humans disagree. Most "weeds" have some benefits, such as erosion control, recycling nutrients, gene pool, esthetics, etc. Perhaps a better definition might be "Weeds are plants whose negative characteristics outweigh their positive characteristics". This encourages us to be somewhat more thoughtful in managing vegetation, and to not automatically bludgeon a plant just because it appears in some weed book.

Weeds are a problem because they reduce crop yields, they increase costs of production, and they reduce the quality of crop and livestock products. In addition, some cause skin irritation and hay fever, and some are poisonous to man and livestock. Weeds also can spoil the beauty of turf and landscape plants.

Weeds harm desirable plants by:

- competing for water, nutrients, light, and space.
- contaminating the product at harvest.
- harboring pest insects, mites, vertebrates, or plant disease agents, and
- releasing toxins in the soil which inhibit growth of desirable plants.

Weeds may become pests in water by:

- hindering fish growth and reproduction,

- promoting mosquito production,
- hindering boating fishing, and swimming,
- clogging irrigation ditches, drainage ditches, and channels, and
- adversely affecting the esthetics of the site, i.e., causing unpleasant odors.

Weeds can harm grazing animals by:

- poisoning, and
- physical damage.

They can cause an "off-flavor" in milk and meat.

Weeds are undesirable in rights-of-way because they:

- obscure vision, signs, guideposts, crossroads, etc.,
- interfere with telephone and power lines,
- increase mowing costs,
- cause upheaval of paved surfaces,
- hinder travel,
- increase hazard from fire,
- provide cover for rodents and other pest animals, and
- clog drainage areas.

## DEVELOPMENT STAGES

Describing various stages of a plant's life cycle can be useful in making or following recommendations for using herbicides.

- ***dormant seed***--Ungerminated seed that would not germinate even if placed in proper conditions.
- ***non-dormant seed***--Seed that need water, light, or oxygen to germinate. Tillage may bring seed sufficiently close to the surface that a new stand of weeds results.
- ***seedling***--small new plants arising from seeds. May be important to distinguish these from new shoots arising from underground vegetative parts.
- ***rosette***--a circular cluster of leaves that forms after the early seedling stage but before a flower stalk is sent up.
- ***bud stage***--earliest stage of reproductive growth. Stage just before bloom when flower parts are forming but flower has not yet opened.
- ***bloom***--flowers have opened. May be further described as early, mid-, or late bloom.
- ***maturity***--seed has formed and the plant is relatively inactive. There is little or no energy production or movement of water and nutrients.

## Some specific items referring to grasses:

- ***spike stage***--very early emergence stage, in which the leaves are still within the coleoptile or tightly rolled to form a spike. Usually when the grass is less than 1 inch tall.
- ***tillering stage***--formation of erect shoots or tillers from the crown of a grass. Also called "stooling".
- ***jointing stage***--begins after tillering when the first node of the stem appears above the soil surface.
- ***boot stage***--when the inflorescence (head) expands the upper leaf sheath. Head is swollen but not yet visible.
- ***milk* and *dough stage***--kernels are not yet ripe and gradually become more dry and firm.

## Other terms:

- ***Crook stage***--when a broadleaf seedling has broken through the soil and before the stem has become erect.
- ***flag stage***--early postemergence stage of onion seedlings between the "crook" stage and the emergence of the first true leaf. The bent tip of the seed leaf resembles a flag attached to a staff. Also referred to as the "knee" stage.

## LIFE CYCLES

### Annuals

Plants with a one-year life cycle are annuals. They grow from seed, mature, and produce seed for the next generation in one year or less. There are two types:

**Summer annuals** are plants that grow from seeds that sprout in the spring. They grow, mature, produce seed, and die before winter. Examples: crabgrass, foxtail, pigweed, lambsquarters, Russian thistle, kochia, barnyardgrass, nightshades, many others.

**Winter annuals** are plants that grow from seeds that sprout in the fall. They grow, mature, produce seed, and die before summer. Examples: cheat, henbit, fiddle-neck, chickweed.

### Biennials

Plants with a two-year life cycle are biennials. They grow from seed and develop a heavy root and compact cluster of leaves (called a rosette) the first year. In the second year, they mature, produce seed, and die. Examples: mullein, bull thistle, tansy ragwort, wild carrot.

### Perennials

Plants which live more than two years and may live indefinitely are perennials. Perennial plants may mature and reproduce in the first year and then repeat the vegetative, seed production, and maturity stages for several following years. In other perennials, the seed maturity and production stages may be delayed for several years. Some perennial plants die back each winter; others, such as trees, may lose their leaves,

but do not die back to the ground. Most perennials grow from seed; many also produce tubers, bulbs, rhizomes (below-ground rootlike stems), or stolons (above-ground stems that produce roots).

*Simple perennials* send down a tap root and form crown buds. They normally reproduce by seeds. However, root pieces left by cultivation can produce new plants. They do not spread vegetatively without help from humans, animals, or machinery. Examples: dandelions, plantain, curly dock, false dandelion, sagebrush.

*Bulbous perennials* may reproduce by seed, bulblets, or bulbs. Wild garlic, for example, produces seed and bulblets above ground and bulbs below ground.

*Creeping perennials* produce seeds but also produce rhizomes (below-ground stems), or stolons (above-ground stems that produce roots). Many also spread by lateral roots. Examples: johnsongrass, field bindweed, Canada thistle, Russian knapweed, yellow nutsedge, leafy spurge.

## PLANT TYPES

### Land Plants

Most weeds on land are grasses, sedges, or broadleaves.

### Grasses

Grass seedlings have only one leaf as they emerge from the seed. Their leaves are generally narrow and upright with parallel veins. Most grasses have fibrous root systems. The growing point on seedling grasses is sheathed and located below the soil surface during the early part of their life cycle. Some grass species are annuals; others are perennials.



## **Sedges**

Sedges are similar to grasses except that they have triangular stems and three rows of leaves. They often are listed under grasses on the pesticide label. Most sedges are found in wet places, but principal pest species are found in fertile, well-drained soils. Yellow nutsedge is a perennial weed species which produces rhizomes and tubers.

## **Broadleaves**

Broadleaf seedlings have two leaves as they emerge from the seed. Their leaves are generally broad with netlike veins. Broadleaves usually have a taproot and a relatively coarse root system. All actively growing broadleaf plants have exposed growing points at the end of each stem and in each leaf axil. Perennial broadleaf plants also may have growing points on roots and stems above and below the surface of the soil. Broadleaves contain species with annual, biennial, and perennial life cycles.

## **Others**

Weeds not in the above groups include spore-bearing plants, as field horsetail and bracken fern; conifers, such as juniper; and some monocots, such as wild garlic, wild iris, cattails, and rushes.

## **Aquatic Plants**

### **Vascular Plants**

Many aquatic plants are similar to land plants and have stems, leaves, flowers, and roots. Most act as perennial plants--dying back and becoming dormant in the fall and beginning new growth in the spring. They are classified as:

- emergent (emersed)--most of the plant extends above the water surface. Examples are cattails, bulrushes, arrowheads, and reeds.
- floating--all or part of the plant floats on the surface. Examples are waterlilies, duckweeds, waterlettuce, and waterhyacinth.
- submergent (submersed)--all of the plant grows beneath the water surface. Examples are watermilfoil, elodea, naiads, pondweeds (Potamogeton), and coontails.

Emergent and floating plants, like some land plants, have a thick outer layer on their leaves and stems which hinders herbicide absorption. Submergent plants have a very thin outer layer on their leaves and stems and are very susceptible to herbicide injury.

## **Algae**

Algae are aquatic plants without true stems, leaves, or vascular systems. For control purposes, they may be classified as:

- plankton algae--microscopic plants floating in the water. They sometimes multiply very rapidly and cause "blooms" in which the surface water appears soupy green, brown, or reddish brown, depending on the algal type.
- filamentous algae--long, thin strands of plant growth which form floating mats or long strings extending from rocks, bottom sediment, or other underwater surfaces. Examples are cladophora and spirogyra.

- macroscopic freshwater algae--these larger algae look like vascular aquatic plants. The two should not be confused, because their control is different. Many are attached to the bottom and grow up to 2 feet tall; however, they have no true roots, stems, or leaves. Examples are chara and nitella.

## Parasitic Seed Plants

Dodders, broomrape, witchweed, and some mosses are important weeds on some agricultural, ornamental, and forest plants. They live on and get their food from the host plants. They can severely stunt and even kill the host plants by using the host plant's water, food, and minerals. These plants reproduce by seeds. Some can also spread from plant to plant in close stands by vining and twining.

## TIMING OF HERBICIDE APPLICATION IN RELATION TO LIFE CYCLES

The relative sensitivity of plants at different times is an important consideration when applying herbicides. When using herbicides selectively in crops, the objective is to find the best combination of a relatively susceptible stage of weed growth and relatively tolerant stage of crop growth.

Postemergence herbicides can be divided into two groups as follows: (a) those that move through the plant in the food stream -- phenoxy, dicamba, glyphosate, amitrole; (b) "contact" type herbicides, such as paraquat, diquat, and bromoxynil.

## A. Weed Susceptibility

1. All weeds are more sensitive at the seedling stage, whether they are classified as an annual, biennial, or perennial. Whenever possible, herbicides of any type, foliar-absorbed or root-absorbed, should be applied when weeds are young, succulent, and growing rapidly. Almost always, the smaller the seedling, the better the control. Also, competition at that time has not yet become significant.
2. Biennials are best controlled when they are in the seedling or rosette stage. The rosette stage may be too late for contact-type herbicides, but many biennials are still sensitive to growth-regulator type herbicides at the rosette stage. Such biennials as bull thistle, mullein, tansy ragwort, musk thistle, etc., often become much less sensitive to growth regulator herbicides after they send up a flowering stalk. The reason is not known.
3. Perennials also are best controlled at the seedling stage, but this is not always possible. If a perennial plant has become established in an area and is truly perennial in nature, it likely will be fairly resistant to contact-type herbicides. With translocated herbicides, the recommended time is usually at the early- to late-bud stage. This growth stage often coincides with the time when carbohydrate flow is diverted from formation of new

vegetative growth and is, instead, sent to replenish depleted root reserves. The herbicides are carried with the carbohydrates to the roots and therefore do a more effective job of preventing regrowth of the perennial plant.

Canadian workers have found that the bud stage may not always be the optimum time for growth-regulator herbicides on Canada thistle. In that area, Canada thistle plants that emerge in August when days are becoming shorter do not elongate but remain as rosettes. These plants were four times as sensitive to dicamba as plants that had emerged in the spring and were sprayed in the bud stage. Also, clopyralid (Stinger, Curtail) seems to be more effective on Canada thistle applied as soon as most thistles have emerged than later at the bud stage.

4. Some of the herbicides used for wild oat control are much more effective at a particular growth stage. Diclofop-methyl (Hoelon) can control wild oats over a wide range, being most effective at the 1- to 4-leaf stage. Difenzoquat (Avenge) is less effective on small wild oats, but more effective on the weed up through the 5-leaf stage. Assert is most effective applied earlier than Avenge, about the 2- to 4-leaf stage.

## **B. Crop Tolerance**

### **1. Growth-regulator herbicides.**

The influence of growth stage on tolerance to 2,4-D, MCPA, and dicamba has been studied extensively on small grains, corn, and sorghum. In general, these crops are especially susceptible during periods of rapid

floral development, including spikelet initiation, initiation of flower parts, and during pollination. For small grains, from germination to the 4-leaf stage is considered more susceptible. Research in Britain has indicated that phenoxy applications to winter grains should be delayed until the sheath of the first leaf is 2 inches. The fully-tillered stage is fairly tolerant and is considered the best time to spray, since weeds are small, more easily killed, and have not yet caused serious competition.

As the stem begins to elongate and nodes appear above ground, the plant again becomes more sensitive. Only after the soft dough stage of the wheat grain can growth-regulator herbicides be applied. By that time, the primary objective would be to dry down some weeds to aid in harvest.

2,4-D may be applied to corn from emergence to the 8-10" stage, after which drop-nozzles should be used. It should not be applied from tasseling to the dough stage.

There is a wide degree of variation in susceptibility with stage of development in broadleaf crops. Small-seeded legumes tend to become more tolerant to most herbicides as they grow older. However, seedling alfalfa tends to be more tolerant to 2,4-DB than older alfalfa, possibly because the alfalfa may gradually develop more ability to degrade the non-toxic 2,4-DB into phytotoxic 2,4-D.

## IDENTIFICATION OF WEEDS

The Agriculture-Herbicide exam will include identifying some color photos from the following list (scientific names are not required). The photos will be of species included in each of two books: "Weeds of the West", available from your local extension office, and "A Guide to Selected Weeds of Oregon", available from the Oregon Department of Agriculture, Commodity Inspection Division/Weed Control. In case either is out of print, loan copies likely are available for study from a local chemical outlet or the extension office. A large number of copies have been sold in Oregon in recent years.

1. Field bindweed *Convolvulus arvensis*
2. Canada thistle *Cirsium arvense*
3. Field horsetail *Equisetum arvense*
4. Green foxtail *Setaria viridis*
5. Barnyardgrass *Echinochloa crus-galli*
6. Downy brome *Bromus tectorum*
7. Wild oat *Avena fatua*
8. Quackgrass *Agropyron repens*
9. Yellow nutsedge *Cyperus esculentus*
10. Lambsquarters *Chenopodium album*
11. Pigweed *Amaranthus* sp.
12. Hoary cress (whitetop) *Cardaria draba*
13. Wild carrot *Daucus carota*
14. Hairy nightshade *Solanum sarrachoides*
15. Jointed goatgrass *Aegilop cylindrica*
16. Russian knapweed *Centaurea repens*
17. Mayweed chamomile *Anthemis cotula*
18. Coast fiddleneck *Amsinckia intermedia*
19. Russian thistle *Salsola* sp.
20. Bull thistle *Cirsium vulgare*

## STUDY QUESTIONS FOR CHAPTER 1

1. What is a rosette? spike stage? flag stage of onions? tillering stage? jointing stage.
2. Define a "weed". Why might there be disagreement about whether a plant is a weed or not?
3. Give five ways in which plants generally called weeds can be beneficial. Five ways they can be detrimental.
4. What is the difference between summer annuals and winter annuals? Give three examples of each.
5. What is the difference between a biennial and a winter annual? Name two biennials.
6. How do simple perennials spread?
7. How do creeping perennials spread? Can they form seeds?
8. How do the leaves of broadleaves and grasses differ?
9. How do you distinguish between grasses and sedges?
10. What is dodder?
11. Contrast the optimum time for applying 2,4-D to a biennial vs. a creeping perennial.
12. In general, at what stage is 2,4-D least likely to injure winter wheat?
13. Learn to identify by sight the 20 weeds listed. It is not necessary to learn scientific names.

## CHAPTER 2 ADJUVANTS FOR HERBICIDE SPRAYS

An adjuvant can be defined as - "a substance added to a pesticide mixture to help the main ingredient do a better job." Possible reasons for the addition of adjuvants to the spray tank when using herbicides include improved wetting, evaporation reduction, increased penetration, improved translocation, extended weatherability, slow release, pH adjustment, deposition, compatibility aid, drift retardation, or odor inhibition. A few of the types of adjuvants of particular importance for herbicide users are discussed below.

### SURFACTANTS

The word surfactant is a hybrid word derived from "surface active agent". Surfactant molecules are sort of double-ended ones. They are made up of a lipophilic portion and a hydrophilic portion (See Figure 2-1).

The lipophilic portion is usually made of

long-chain hydrocarbons or benzene type ring structures that are very low in water solubility but high in oil solubility. The hydrophilic end has a high affinity for water.

The primary classes of surfactants are anionic, cationic, or nonionic. This is determined by the chemical structure of the hydrophilic portion of the molecule. An anionic surfactant ionizes in water to form a negatively charged hydrophilic portion. A cationic surfactant ionizes to form a positively charged hydrophilic part. These two types can be very useful for specific purposes, but they may react with contaminants in the spray solution. For example, anionic type surfactants can form insoluble precipitates in hard water. Most commonly used agricultural surfactants are nonionic. They are easy to use, non-toxic, and are not affected by hard water.

An example of each type of surfactant is illustrated in Figure 2-2.

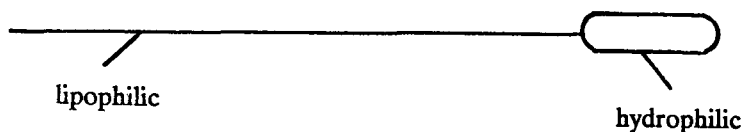

Figure 2-1.

Figure 2-2. Examples of three types of surfactants. The lipophilic part is left of the dotted line and the hydrophilic part is to the right.

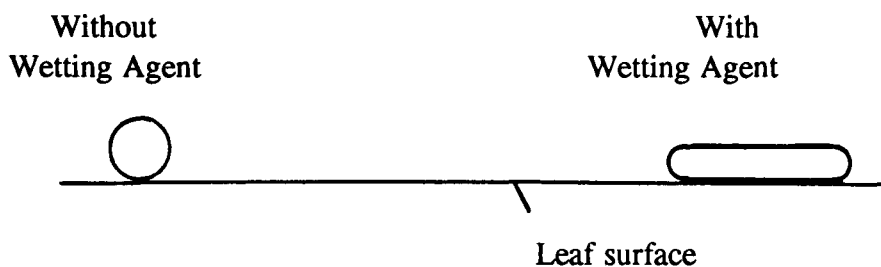
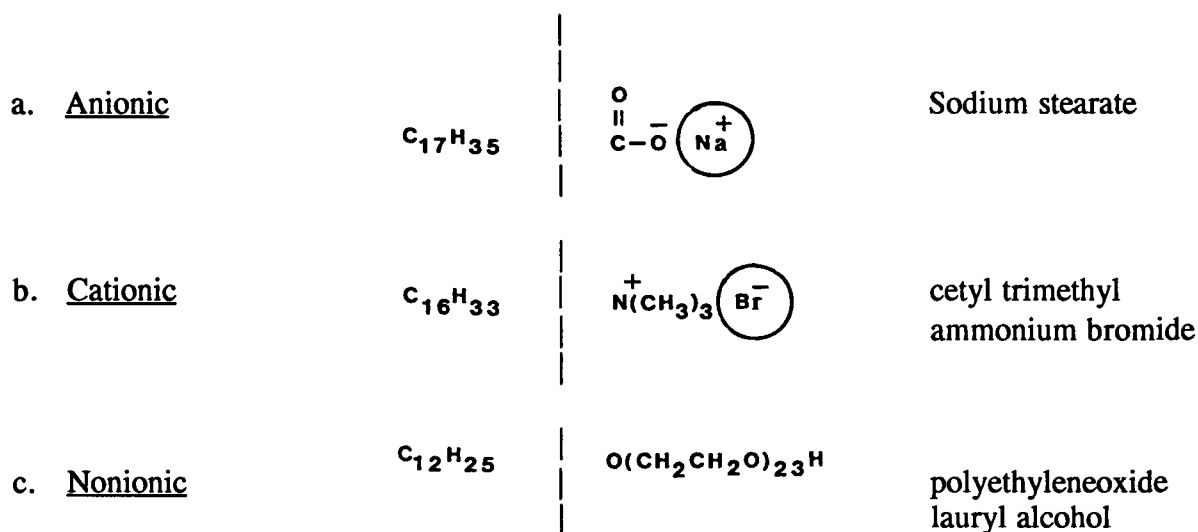

Figure 2-3. Water droplet on a leaf surface, with and without a wetting agent.

Specific surfactants can be used in many ways including use as wetting agents, dispersing agents, emulsifiers, foaming agents, detergents, etc. Some of these uses are primarily concerned with formulation of

the commercial product, which will be discussed in another chapter.

A wetting agent is added to herbicides to spread the spray droplets over the surface

of the leaves, thus increasing coverage and eventual uptake of the herbicide (Figure 2-3).

All of the details of this process are not yet well understood. We know that maximum reduction of surface tension of spray droplets can usually be achieved with concentrations of wetting agent of less than .1%. This means that, above that amount, increasing the rate of surfactant will not cause the spray droplet to spread out any further. But we also know that uptake and effectiveness of many herbicides continue to increase as we increase the wetting agent concentration above .1%. This tells us that there are other ways in which a surfactant improves uptake of the herbicide besides simply reducing the surface tension of the spray solution.

Because wetting agents can increase herbicide uptake in leaves, particularly waxy ones, adding a wetting agent might cause greater injury to the crop. If part of the reason for selectivity is that the crop is hard to wet and the weed is easily wet, a wetting agent might increase herbicide uptake more in the crop than in the weed and thus would be counterproductive. Also, wetting agents cost money, so if weeds are easily wet without additional wetting agent, there is no need to spend the extra money.

Persons who have done a great deal of work on research with surfactants usually find a particular surfactant that is ideal for a specific herbicide on a particular species. This, of course, greatly complicates the problems involved in making recommendations for herbicides that may be used on a wide range of weed species. As a result, recommendations usually include a few commonly known surfactants that have been shown to be reasonably effective over a wide range of herbicides and species. Household detergents are designed for an entirely

different purpose and are usually considerably less effective as adjuvants for herbicide sprays.

## SURFACTANT-OIL BLENDS

Increasingly popular in recent years have been formulations containing phytobland (non-phytotoxic) oils and a significant concentration of surfactant (generally 4 to 10%). Examples are MorAct and Herbimax. These products tend to be more effective in improving herbicide retention and uptake than surfactants alone. Some herbicide labels specify their use, usually at about 1 quart/acre.

## OILS

Oils have been used in herbicide sprays for many years. These oils can be divided into three types:

a. **Phytotoxic--non-selective.**

These are heavy oils with a high degree of unsaturation (many double and triple bonds). The high degree of unsaturation makes the molecules readily sulfonated, hence giving them a low unsulfonatable residue (USR). These oils are generally added to knockdown-type herbicides for road spraying, canal and ditchbank spraying, etc. Diesel fuel is an example.

b. **Phytotoxic - selective.** These oils are not actually adjuvants because they may be sprayed directly without mixing them with water or without combining them with any herbicides. They are intermediate in viscosity and percent USR. They are used mostly for broadleaf weed control in certain crops such as the carrot family. The carrot family apparently



is better able to withstand the effects of the oil on membrane systems than most common weeds, so the crop plant is not harmed while the weeds are controlled. An example of this type is Stoddard Solvent.

c. **Phytobland oil-water emulsions.**

These are light oils that are nearly saturated chemically, thus having a high % USR. This means there are very few double or triple bonds in their structure as places for sulfonation, so they have a high percent of unsulfonatable residue. These oils are not phytotoxic by themselves but are often added to herbicides that need help in penetrating leaves of plants. They are sometimes called corn oils, superior spray oils, supreme spray oils, and other common names. A major use in the past has been in mixtures with atrazine for postemergence application in corn.

Other types of additives include buffering agents (for adjusting acidity of the spray solution), foaming agents (for markers), anti-foaming agents, odor inhibitors, stenching agents, and emetics (induce vomiting).

## **DRIFT RETARDANTS**

When a spray solution is atomized by forcing through a spray orifice under pressure, there are formed a large number of extremely fine spray droplets along with the normal size spray droplets. These "fines" can easily be diverted from the target area with even a slight breeze. If the herbicide is sufficiently phytotoxic, if the breeze is sufficiently strong, or if the numbers of fines produced by the spraying operation is sufficiently large, serious damage can result to non-target species. For this reason, products have been developed to reduce the number of fines, thus reducing drift. Such products, such as Nalco-Trol, can simply be added to the spray tank and do not require any special application equipment. Care must be taken to insure that the change in character of the spray solution will not result in increased damage to the sprayed crop.

## STUDY QUESTIONS FOR CHAPTER 2

1. Define an "adjuvant".
2. Is a surfactant a particular type of adjuvant, or is an adjuvant a particular kind of surfactant?
3. Describe the "double-ended" nature of surfactants.
4. What are the three primary classes of surfactant? What are some characteristics of each? Which is the class most often used with herbicides?
5. About 0.1% (1 pt per 100 gal) of wetting agent causes maximum reduction in surface tension. Does it help to add more?
6. Give two reasons why adding a wetting agent may not be advisable.
7. What does phytobland mean?
8. What does USR mean? How does it help you decide which oil to buy?
9. How do drift retardants reduce drift?
10. List 8 types of adjuvants.
11. What is an emetic?
12. In what type of crop might a phytotoxic-selective oil be used?
13. What is a buffering agent?



## CHAPTER 3 HERBICIDE FORMULATIONS

### Introduction

Once an operator has selected a herbicide, he must decide which formulation to use. There may be several available formulations of the product. In this case, the proper selection of formulation can mean the difference between failure and success. Proper handling and application varies between types of formulations. Therefore, a basic knowledge of herbicide formulation is important to the operator.

In general, formulating means preparing a product for practical use. The formulation can influence the accuracy of application, the effectiveness of pest control in a particular situation, the selectivity of certain herbicides, the convenience to the operator, and, very significantly, the cost of the treatment.

Herbicides are mainly applied as sprays or as dry materials. Some fumigants such as methyl bromide are applied as a gas. Spray formulations include water solutions, oil-soluble liquids, soluble powders, emulsifiable concentrates, flowable formulations, wettable powders, dispersible granules or dry flowables (same thing), invert emulsions, and encapsulated formulations. Dry materials are formulated as granules or water-soluble pellets.

Many factors must be considered in deciding how to formulate a specific active ingredient. These can include:

#### 1. Chemical and physical properties of the herbicide.

The solubility of the herbicide in various solvents is of major importance. The volatility of the material may also dictate the type of formulation prepared.

#### 2. Intended use.

If a herbicide is intended to be used as a foliar or bark application for control of waxy or brushy species, it likely will be formulated in some type of oily formulation, whereas if it is intended for use as a selective treatment, it may be more likely to be formulated with less oil and less wetting agents. If it is designed to control small weeds in a growing crop through soil activity, it may be formulated as a granule to allow it to filter through the foliage canopy to the soil.

#### 3. Geographical area of use.

The customs of growers in various parts of the country differ. Many farmers in the Midwest of the U.S. own granular spreaders and have become accustomed to using granular products, whereas in the more arid West, granules tend to be less consistent in performance and are less readily accepted by growers.

#### 4. Materials available for formulation.

Some manufacturers have switched formulations because of a lack of supply of solvents, emulsifiers, and containers.

## 5. Economics.

An economic analysis could include several of the factors given above. The cost of the formulating materials, of containers, of relative shipping costs, and other factors must all be considered. In general, formulations with a low percentage of active ingredient such as granules are most expensive to the grower. Large increases in the costs of solvents and emulsifiers in recent years has changed the economic picture relative to emulsifiable concentrates. The relative cost of formulation may not be of major importance in certain high value crops, but in other crops the cost of the product is critical for acceptance by the grower.

## Abbreviations

Abbreviations often are used to describe the type of formulation involved. These abbreviations are used on labels and in recommendations. Some of the common ones are: WP for wettable powder; F for flowable; G for granules or granular; D for dusts; SP for soluble powder; EC for emulsifiable concentrate; and SC for spray concentrate.

## Spray Formulations

1. **Soluble concentrates.** In these products, the active ingredient can be dissolved readily in either water or oil to form a true solution. A

solution is a homogeneous mixture formed by dissolving one or more substances (whether solid, liquid, or gaseous) in another substance. The chemical being dissolved is called the solute, and the substance in which it is being dissolved is the solvent.

With a water-soluble herbicide the manufacturer may dissolve the material in water and sell the product as a concentrate for further dilution by the user. In general, the herbicide should be soluble at least to the extent of 1 lb/gal of water in order to be sold as a liquid concentrate for agricultural purposes.

The manufacturer may choose to sell a water-soluble herbicide as a dry powder for mixing with water by the user.

Adjuvants may be added to water-soluble products to improve their application and effectiveness. Wetting agents are commonly added and sometimes sequestering agents are added to prevent precipitation in hard water.

Major advantages of water-soluble herbicides are relatively low cost of formulation and the fact that no agitation is required in the spray tank once the materials have been thoroughly dissolved. Problems which may arise from the use of soluble herbicide formulations are as follows:

- a. They may react with hard water, causing clogging of the spray equipment or rendering the herbicide non-toxic.

- b. The active ingredient may not enter the plant foliage readily. This can be due to the excessive surface tension of the water which leaves the herbicide crystals on the foliage. This characteristic may be desirable when selectivity of the compound is based upon differential wetting, but it may be undesirable if non-selective treatment is the goal or if the weeds being treated are waxy.
- c. The chemical might be readily leached through the soil by water. This can be an advantage when applying a herbicide to control deep-rooted perennial weeds; however, with selective preemergence herbicides, this can be an undesirable property as it may be leached by excess rain or irrigation, giving only short residual control, ineffective performance, or injury to the crop.

## 2. Emulsifiable concentrates.

Some herbicides cannot be directly dissolved in water. However, they may be soluble in a non-polar organic solvent such as xylene, then mixed with water to form an emulsion. An emulsion is a mixture in which one liquid is suspended in tiny globules in another liquid. The most common type of emulsion would be represented by oil droplets suspended in water. Usually when we mix oil in water, the two separate rather rapidly. If we add the proper emulsifying agent (a surfactant), we can form a much more stable emulsion. The reason for this is that the emulsifier molecules orient themselves around the oil droplet as shown in the Figure 3-1.

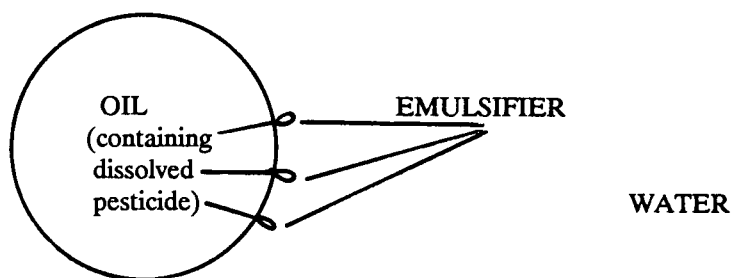

Figure 3-1. Oil droplet suspended in water to form an emulsion. Surfactant molecules are acting as an emulsifier to help keep the drop suspended.

The lipophilic (oil soluble) end of the surfactant extends into the oil droplet and the hydrophilic (water soluble) part is attracted to the water phase. As long as these oil droplets remain very small, they will stay suspended in the water for long periods of time. It is when they coalesce, or come together to form large droplets, that they begin to separate out from the water. The emulsifying agent helps prevent the droplets from coalescing by surrounding the molecule with hydrophilic ends of the surfactant. The hydrophilic part of the surfactant repels an adjoining oil droplet. Thus, a stable emulsion with thousands of tiny globules suspended in the water is formed.

An emulsifiable concentrate, then, consists of a non-polar solvent, the herbicide dissolved in the solvent, and an emulsifying agent. When this emulsifiable concentrate (EC) is added to water in a spray tank, a stable emulsion is formed as described above. Tiny solvent droplets are dispersed throughout the water carrier, each solvent droplet containing some dissolved herbicide (Figure 3-1). The herbicide is not dissolved in the water, it is simply suspended in the water by being dissolved in the non-polar solvent. The emulsifying agent acts as shown in the figure above by keeping the solvent droplets dispersed. Hundreds of emulsifiable concentrates are on the market.

Suppose you are handed a sample of a liquid concentrate containing herbicide, how could you tell whether it is an emulsifiable

concentrate or a true water solution? It is quite simple. You simply pour each of them in a container of water and agitate slightly. The water-soluble concentrate will form a clear solution, although it might be somewhat colored. The emulsifiable concentrate will immediately form a milky appearance in the water. Indeed, milk is an excellent example of a natural emulsion. It is simply fat globules suspended in a water medium with casein as the emulsifier.

In order to formulate a herbicide as an emulsifiable concentrate, adequate solubility in non-polar solvents is required. A solubility of at least 1 lb/gal is required for an economic E.C.. Most EC's contain at least 2 lb/gal and a few contain as much as 8 lb of the active ingredients per gallon.

An E.C. penetrates the waxy foliage of leaves better than other formulations. This means that they may be more effective against hard-to-kill weeds, but they also may be less selective than other formulations. They can be applied in hard water without adverse reactions. They are less likely to be washed off the foliage by rain or sprinkler irrigation. They are less abrasive to pumps and sprayer parts than are wettable powders, and they suspend in the tank for longer periods of time than wettable powders. However, the user should recognize that the emulsion in the spray tank is still a suspension and requires some agitation to keep the emulsion from separating.

Emulsifiable concentrates and emulsions are more easily absorbed by the skin than wettable powders and dusts and are thus more hazardous if spilled or splashed on the operator.

### 3. Wettable powders.

Sometimes a new herbicide is not soluble in water nor is it soluble enough in organic solvents. In that case, the material can be ground very finely and formulated as a wettable powder (WP). A WP is defined as a powder that will readily form a suspension in water.

Wettable powders are formulated by impregnating the technical herbicide on an inert material such as clay. A wetting agent and dispersing agent are added to the formulation. The wetting agent helps wet the technical herbicide when added to the water so that the material does not simply float on top. The dispersing agent aids in spreading out the individual particles throughout the water. A typical 50% WP may contain 42% clay, 2% wetting agent, 2% dispersing agent, 4% other impurities, and 50% technical herbicide (active ingredient). This will be indicated on the label as 50% active ingredient and 50% inert material.

Since wettable powders are suspensions and not true solutions, considerable agitation is necessary to prevent settling out. An analogy would be the silt being carried along by a river. As long as the water is kept turbulent, the materials can remain suspended. Wettable powders generally have less

foliar activity than other types of spray formulations. In fact, herbicides have been formulated as a WP, even though they could be formulated as an EC, because of reduced injury to the crop (as well as sometimes lower cost). When applied to the soil, they generally require activation by rain or sprinkler irrigation. They tend to be abrasive on pumps and nozzle tips of spray equipment. Since they generally contain a rather high percentage of active ingredient, and no solvents or metal containers are needed, the cost per unit of active ingredient tends to be lower than with many other formulations.

Some wettable powders are sold in water-soluble bags, which are simply added to the spray tank. This can be useful when (a) the rate required is very low, making weighing difficult, or (b) some question has been raised about toxicology; the bag allows the user to avoid any contact with the herbicide.

Wettable powders should be mixed with a small amount of water to form a slurry before mixing with water in the tank. This helps disperse it in the water and assures a maximum amount of technical herbicide in suspension.

### 4. Flowables.

Flowable formulations are concentrates of a liquid or solid herbicide suspended in a liquid. The most common flowables on the market contain very finely ground herbicide as a powder suspended in water. In some respects, it is a prepackaged slurry for addition to the spray tank. Once it is dispersed in water, it is nearly the same as a



wettable powder. Since this formulation is a suspension and not a solution, thorough agitation in the container is required before measuring out material from the container.

#### **5. Dispersible granules or dry flowables.**

This relatively recent formulation is becoming increasingly popular. The two names, 'dispersible granules' or 'dry flowable', mean the same. The formulation consists of small beads which disperse into a suspension when added to water. The spray mixture must be agitated, as with the wettable powders. The dispersible granules have very little dust problem and can be measured by volume as well as by weight. Glean, for example, has been sold with a graduate cylinder for accurate measurement. Some difficulties have been encountered in mixing some dry flowables with liquid fertilizer. Try suspending the formulation in water in a quart jar, using appropriate concentrations, before mixing up a whole tankful.

A new formulation related to dispersible granules are tablets. Some herbicides used at very low dosages per acre are formulated in effervescent tablets (like Alka Seltzer) to be counted out and tossed into the spray tank. They become dispersed and essentially become like a wettable powder or dispersible granule.

#### **6. Invert emulsions.**

An invert emulsion is one in which water is the discontinuous phase and oil is the continuous phase. This

results in a thick mayonnaise-like product. The primary reason for formulation of invert emulsions is to reduce drift from airplane applications or from handgun applications along roadsides and railroads. Special emulsifiers are required to form an invert emulsion and special equipment is needed for its application.

#### **7. Encapsulated formulations.**

New methods have been developed to trap small amounts of herbicide in tiny capsules, which are then suspended in a liquid. This concentrate can then be mixed with water and applied through a regular sprayer. The purpose of encapsulating herbicides is to obtain a controlled release of the material over a period of time in order to prevent excessive loss by evaporation or from excessive leaching.

Polyvinyl chlorides and other plastics are being studied as slow-release compounds for herbicides. While still in liquid form, the herbicide is mixed with the plastic. As the plastic hardens, the herbicide is trapped in tiny compartments to be released slowly as the plastic breaks down.

### **Formulations Applied Dry**

#### **1. Granules.**

Granular formulations contain from 2 to 20% concentrations of herbicide in particulate solid carriers suitable for direct field application. They are prepared by impregnating the herbicide on inert particles such as clays or on botanical materials such as

ground corn cob or walnut shells. The particles are screened so that the majority of the particles usually fall between 15 and 40 mesh in size.

Granules may be applied with less expensive equipment than sprays and their application is more convenient. They can penetrate a plant canopy and reach the soil easily. They may release herbicides gradually over a period of time, which can be advantageous with certain herbicides. There is less drift hazard with granules, and it is not necessary for a herbicide to be soluble in either water or non-polar solvents to be formulated as granules. The cost of granules tends to be higher than other formulations. There is more chance of poor distribution on the soil than with sprays since granules may roll or blow from the tops of ridges into furrows, for example. Some herbicides that require greater amounts of water for the activation in the soil may be less effective when applied as a granular.

## 2. Pellets.

Pellet formulations are larger than granules and are basically used for spot treatment. Many pellets are formulated in water-soluble materials such as borates rather than non-soluble inert materials as are granules. They have most of the same advantages and disadvantages as granular formulations.

## 3. Dusts.

Dusts usually contain only two ingredients, an inert material, usually a clay, as diluent, and the toxicant. The latter rarely accounts for more than 10% of the weight of

the mixture and is more often about 1%. For this reason they are more costly per pound of toxicant (because of shipping costs). Herbicides are seldom, if ever, sold as dusts.

## Active Ingredient vs. Acid Equivalent

Two terms should be discussed at this point. Active ingredient refers to the chemicals in a product that are responsible for the pesticidal effects. In dry formulations, the active ingredient is expressed as a percentage by weight. A wettable powder may contain 80% active ingredient and a granular product may contain 4% active ingredient, for example. Concentrations of herbicides whose active form is an acid are usually expressed as acid equivalent. This refers to the theoretical yield of parent acid from an active ingredient. That may sound confusing so let us explain further. A particular herbicide such as 2,4-D may be active in the acid form. However, for various reasons, the acid may be prepared and sold as the salt or the ester. The ester or salt is considered to be the active ingredient, but we base our recommendations on the number of molecules of acid/acre, whether in the acid, salt, or ester form. We want to be able to say 1 lb of 2,4-D acid per acre rather than 1 lb of 2,4-D ester per acre. A molecule of 2,4-D ester is heavier than one molecule of 2,4-D acid. Therefore, if we recommend one pound of active ingredient per acre, we would be applying considerably fewer molecules than if we recommended 1 pound of acid equivalent. To avoid this we convert everything to the weight of acid rather than consider the total weight of the active ingredient.

In Figure 3-2 are sections of labels from two 2,4-DB formulations. Note that the active

# Butyrac<sup>®</sup> 200

## Broadleaf Herbicide

Controls Broadleaf Weeds in Soybeans, Peanuts, Alfalfa, Trefoil and Clovers.

KEEP OUT OF REACH OF CHILDREN  
DANGER

**ACTIVE INGREDIENT:**

4-(2,4-Dichlorophenoxy)butyric acid,  
dimethylamine salt\* ..... 25.9%

**INERT INGREDIENTS** ..... 74.1%

\*4-(2,4-Dichlorophenoxy) butyric acid equivalent  
22.0% by weight or 2 pounds per gallon.

# Butyrac<sup>®</sup> Ester

## Broadleaf Herbicide

Controls broadleaved weeds in alfalfa and birdsfoot trefoil.

KEEP OUT OF REACH OF CHILDREN  
WARNING

**ACTIVE INGREDIENT:**

4-(2,4-Dichlorophenoxy) butyric acid,  
butoxyethanol ester\* ..... 34.4%

**INERT INGREDIENTS:** ..... 65.6%

\*4-(2,4-Dichlorophenoxy)butyric acid  
equivalent 24.6% by weight or 2  
pounds per gallon.

Figure 3-2. Labels for two formulations of 2,4-DB.

ingredient totals 25.9% for the amine and 34.4% for the ester, yet both contain 2 lbs acid equivalent/gal.

In case you are wondering why the acid equivalent percentages differ, it is because, while lb/gal is on a weight/volume basis, the percentages are calculated on a weight/weight basis. Because the solvents are different, 2 lbs would be a different percentage of the total weight of a gallon. (Which gallon weighs the most?)

### Tips on Tank Mixing

1. Read the labels carefully for all products you will mix. Follow directions. Some product labels prohibit or limit tank mixes.
2. Do a small scale "jar" test for compatibility as follows:
  - Add pesticide or pesticide pre-mix to water or fluid fertilizer. Use the same water or fluid that you will be using for the field application.
  - Close the jar and shake at least 10 times. Let it sit 5 minutes and look at the results. If the mixture stays mixed, use the combination in your spray tank.
  - Should the mixture separate after 5 minutes, but mixes readily with shaking, the mixture can be used in the tank if good agitation is maintained. If a separate oily layer, large oil globules, clumps of solids or sludge at the bottom forms in jar with adjuvant, the mixture should not be used.
3. When you tank mix in volume, put 2/3 of the carrier in the tank first. Then add pesticides one by one, with wettable

powders first. Agitate for thorough mixing after each addition, before pouring in the next. Finish filling the tank with carrier.

4. Keep agitation going at all times on the way to the field, during application and during stops for any reason. Empty the tank preferably on the day of mixing. Do not allow mixture to stand overnight without agitation. Check labels for temperature and humidity data as they affect mixing or delay in use.
5. With any new combination, test your tank mixture on small areas, at varying rates and conditions of use before large scale use.
6. Use exact dosage rates for registered tank mixes. Changes may cause crop injury or poor performance on weeds or pests.

**Order of mixing:** For compatibility test purposes, where more than 1 pesticide is mixed in water or fluid fertilizer, premix the pesticides in water before adding to the jar or fertilizer or water.

In actual tank mixing for field application, as well as premixing, unless label directions are otherwise, add products to the tank in this order: first wettable powders, then flowables, water solubles, surfactants, and emulsifiable concentrates. Make sure you have good spray tank agitation at all times. Be sure each product is well mixed before adding the next. Keep the mixture agitated throughout application. Do not allow to stand overnight without agitation. It is preferable to apply all of a mixture in one day.

**Precautions:** Check the label first. Not all pesticides work well when combined. The label will indicate if the pesticide shouldn't be mixed with another spray component.

## STUDY QUESTIONS FOR CHAPTER 3

1. What does formulating mean?
2. List 5 important herbicide formulations prepared for spraying.
3. List two formulations for applying dry.
4. What are some advantages and disadvantages of each formulation? Consider costs, agitation, dust problems, wear on nozzles, effectiveness on waxy plants, etc.
5. What is the difference between a dispersible granule and a dry flowable?
6. Once they have been added to the spray tank and mixed with water, how do wettable powders, dispersible granules, dry flowables, and flowables differ?
7. What is the primary reason for formulating a product as an invert emulsion?
8. What is the difference between active ingredient and acid equivalent? For a given product, the percentage of which is likely to be higher?
9. Would you add an EC or a WP to the spray tank first?
10. How can you find out before you mix up a tankful whether a particular EC and WP are compatible?

# CHAPTER 4

## TEN IMPORTANT HERBICIDE FAMILIES

### INTRODUCTION

There are something like 150 active ingredients that are formulated and sold commercially as herbicides in the U.S. Clearly, there is no way that they can all be discussed for our purposes. Ten important families have been selected for discussion. These not only include some of our most important herbicides, but they also represent a wide range of chemical types, translocation types, foliar active vs. soil active, etc.

Chemical structures of a representative within each family are included for your information. It is not necessary to study these structures if you are not interested.

These ten families represent only about 1/3 of the commercial herbicides available in the U.S. Information on other herbicides and more details on the ones discussed here can be found in the Herbicide Handbook of the Weed Science Society of America, 309 West Clark Street, Champaign, IL 61820. Recent editions have been available for around \$25.

### A. GROWTH REGULATOR TYPES

#### (1) Phoxys

##### a. 2,4-D

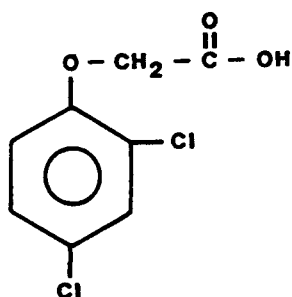

##### b. 2,4-DB

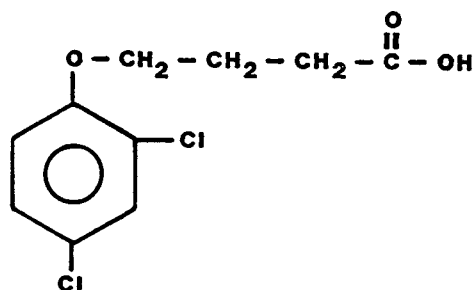

##### c. MCPA

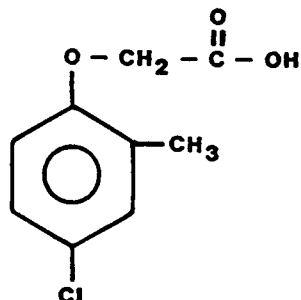

## Important Herbicides

2,4-D	dichlorprop	2,4-DB
2,4,5-T	mecoprop	MCPB
MCPA	silvex	

### General Characteristics

- Volatility and solubility depends on the derivative (ester, amine, etc.) of the phenoxy acid.
- Formulation is also dependent on the solubility of the derivative.

These compounds are either soluble in organic solvents (esters, emulsifiable acid, oil-soluble amines) and formulated as EC's, or they are water-soluble and formulated as aqueous solutions. Oil-soluble amines are being discontinued.

- These herbicides are short-lived in the soil.
- Acute oral mammalian toxicity moderate (in range of 300-1000 mg/kg).

### Mode of Action

- Phenoxy's are absorbed through the foliage and translocated with the sugars.
- Tremendous amount of research conducted but no final answer on how they kill plants. Almost certainly related to malfunctioning of RNA and enzyme synthesis.
- Plug transport system.
- Many other effects.

### Symptoms

- Distorted twisted growth, severe stunting, onion-leaf in grasses, malformed heads in small grains.

### Uses

**2,4-D** - primarily control of broadleaf annuals, biennials, and perennials. Not generally effective on grasses.

Broadleaf control in most of our grass crops including small grains, corn, and turf.

Almost always applied postemergence.

**Dichlorprop (2,4-DP)** - primarily for brush control. Included in a few turf mixtures.

**MCPA** - close relative of 2,4-D; somewhat different weed control spectrum; safer on legumes, but depends on species; safer on small grains. More toxic to carrot family, buttercup family, perhaps thistles.

**Mecoprop (MCP)** - mostly used in turf; controls clovers, chickweed, fairly safe on grass.

**2,4,5-T** - similar properties to 2,4-D; more toxic to brush, legumes. May contain low levels of dioxin. Not legal in the U.S., but used widely around the world.

**Silvex (2,4,5-TP)** - similar to 2,4,5-T, a little more expensive; more toxic to certain brush species than 2,4,5-T; has been used in turf because it is effective on chickweed. May contain low levels of dioxin. Not legal in U.S.

**Butyric compounds (2,4-DB and MCPB)** - not toxic to plants; need to be broken down into the active form (Beta oxidation); depends on enzymes in the plant; if enzyme is lacking, plant

is tolerant; most legumes are tolerant, especially in the young stage.

### Relative cost of derivatives

With all of the phenoxy herbicides, the metallic and regular amine salts and the high volatile esters are cheapest, followed in order by low volatile esters, emulsifiable acid, and oil-soluble amines. Not all derivatives are available with all phenoxy.

\*\*\*\*\*

(2) dicamba (one trade name is Banvel)

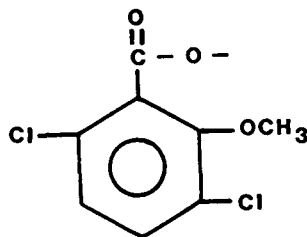

3,6-dichloro-*o*-anisic acid or 2-methoxy-3,6-dichlorobenzoic acid

### General Characteristics

- Volatility is low to moderate.
- Salt derivatives (dimethylamine) are used to increase solubility. Formulated mostly as an aqueous solution but also as granules and soluble granules).
- Soil persistence is longer than the phenoxy, remaining active for a number of months at the higher rates.
- Moderate to relatively low mammalian toxicity.

### Mode of Action

- Taken up by the roots or leaves.
- Translocated either upward in water

stream from roots or downward with sugars and accumulated in areas of high metabolic activity.

- Lethal action is similar to the phenoxy.

### Symptoms

- Distorted, stunted growth, similar to 2,4-D.

### Uses

- Different weed spectrum than 2,4-D; weak on mustards, borages. Toxic to Polygonaceae, Caryophyllaceae; used in combination with 2,4-D; effective on some broadleaf perennials; same general effect as phenoxy; translocates better. Broadleaf control in grass crops, turf, cereals.



\*\*\*\*\*

(3) picloram (one trade name is Tordon)

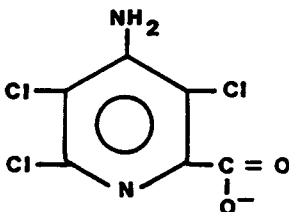

4-amino-3,5,6-trichloropicolinic acid

### General Characteristics

- Volatility is low.
- Salt derivatives used to increase water solubility, formulated as an aqueous solution or as granules.
- Soil persistence is greater than that of dicamba.
- Low mammalian toxicity.

### Mode of Action

- Taken up by foliage and roots.
- Translocated either upward with water or downward with sugars.
- Overall disruption of growth through a number of mechanisms, similar to phenoxy's.

### Symptoms

- Cupping and stunting of leaves, terminal growth ceases, twisting of stems followed by root deterioration.

### Uses

- Selective control of broadleaves in grasses. Misses some weeds as dicamba.
- Non-cropland
- Rangeland and pastures
- Spot treatments of perennial broadleaves.
- Brush control

**NOTE:** Most formulations of picloram are restricted use because of extreme activity on many broadleaves including trees and shrubs; Problems: high activity on non-target plants, persistence in soil.

\*\*\*\*\*

(4) triclopyr (Garlon; it is Crossbow or Turflon when mixed with 2,4-D, )

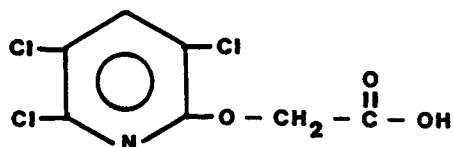

3,5,6-trichloro-2-pyridinyloxy]acetic acid

### General Characteristics

- Similar to comparable formulations of phenoxy herbicides.
- Soil persistence somewhat longer than 2,4-D but shorter than picloram.
- Moderate mammalian toxicity.

### Mode of Action and Symptoms

- Same as other growth-regulator herbicides.

### Uses

- Primarily for brush control in forests, pastures, and non-crop areas.
- Shown to be more effective on blackberries than other herbicides.
- One of the few herbicides (perhaps the only one) that can control oxalis and lawn violets in turf.

\*\*\*\*\*

(5) clopyralid (Stinger; it is Curtail when mixed with 2,4-D, or Curtail M with MCPA).

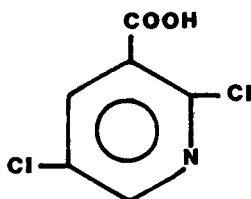

3,6-dichloropicolinic acid

### General Characteristics

- Volatility is low.
- Salt derivatives are used to increase water solubility, formulated as aqueous solution.
- Soil persistence similar to dicamba.
- Low in mammalian toxicity.

### Mode of Action

- Taken up by foliage and roots.
- Translocated upward with water or downward with sugars.
- Overall disruption of growth through a number of mechanisms, similar to other growth regulator-type herbicides.

### Symptoms

- Cupping and stunting of leaves, termi-

nal growth ceases, twisting of stems followed by root deterioration.

### Uses

- Selective control of broadleaves in grasses, including cereals. Although chemically similar to picloram, has quite different spectrum. Excellent for killing composites (such as Canada thistle) and legumes. Ineffective on field bindweed, chickweeds, mustards, figwort family, borages. Also, selective in peppermint, sugarbeets, meadowfoam, strawberries (not all registered, though).
- Non-cropland
- Not a wide-spectrum herbicide, but excellent for some weeds. Probably will be used in special situations (Canada thistle in mint) or as part of a mixture.
- Unlike most other growth regulator-type herbicides, seems to be more effective on Canada thistle much earlier than the bud stage.

# Wheat growth stage in relation to phenoxy herbicides.

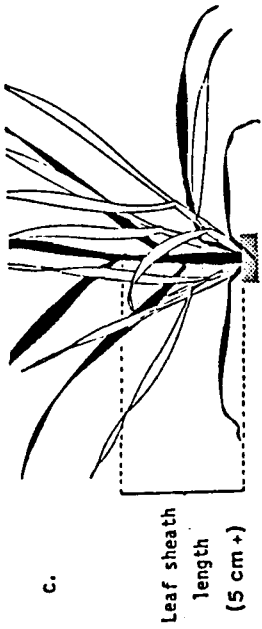
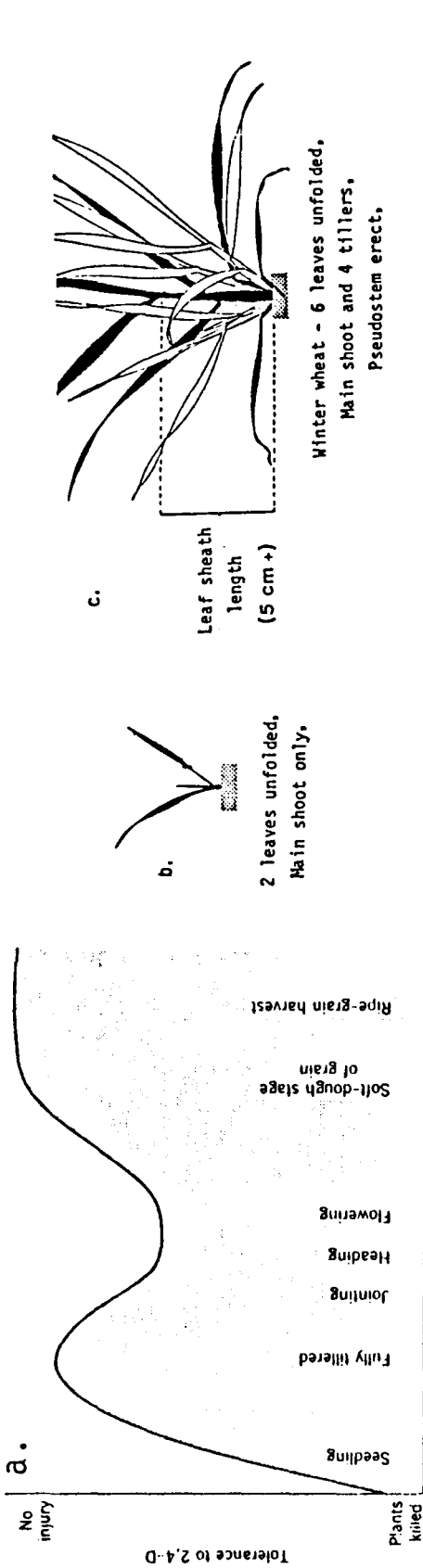

c. Winter wheat - 6 leaves unfolded,  
Main shoot and 4 tillers,  
Pseudostem erect.

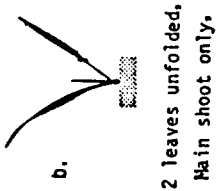

b. 2 leaves unfolded,  
Main shoot only.

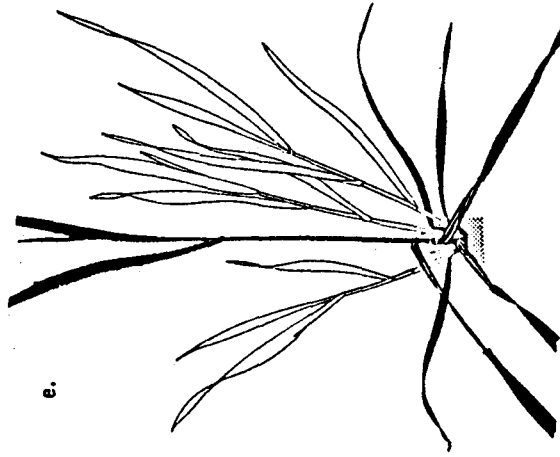

e. 8 leaves unfolded,  
Main shoot and 3 tillers,  
2nd node detectable,  
(Leaf sheaths peeled back)

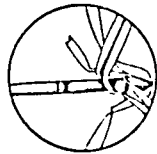

d. 1st node detectable.



f. Flag leaf sheath extending

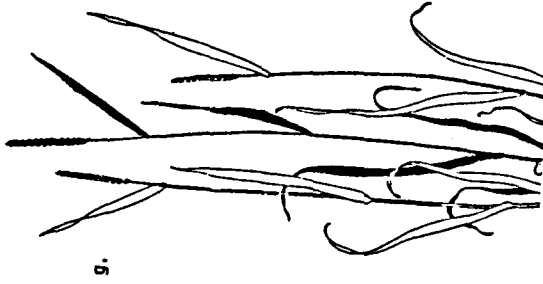

g. Wheat - Main shoot and 4 tillers,  
(2 infertile), 4th node detectable,  
Soft dough stage.

- Wheat growth stage in relation to phenoxy herbicides
- a. General pattern of tolerance to 2,4-D at various growth stages.
  - b. Seeding -- 2-leaf stage.
  - c. Earliest stage that 2,4-D should be applied.
  - d. Early jointing stage. Sensitivity begins to increase.
  - e. 2-node stage. Approximately latest that 2,4-D should be applied.
  - f. Early boot. Too late for most herbicides.
  - g. Soft dough. Phenoxys can be applied for harvest aid.

## B. BIPYRIDILIUMS

### 1. diquat (Reglone)

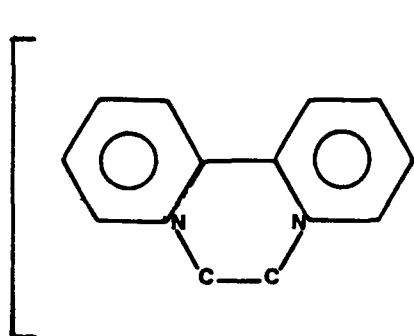

6,7-dihydrodipyridine  
[1,2-a:2',1'c] pyrazinediium ion

### 2. paraquat (Gramoxone)

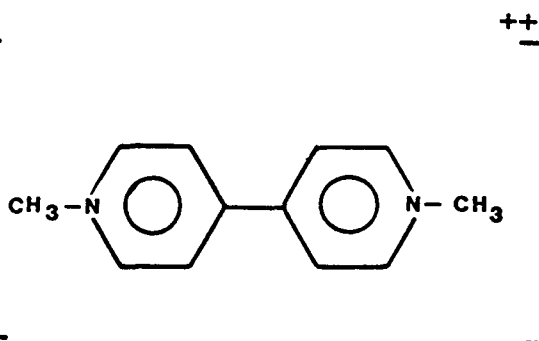

1,1'-dimethyl-4,4'  
bipyridium ion

### General Characteristics

- Non-volatile
- Highly soluble in water, formulated as an aqueous solution.
- Strongly bound to soil particles almost instantly on contact.
- Relatively high in mammalian toxicity.

### Mode of Action

- Rapidly absorbed by the foliage, probably faster than any other herbicide.
- Generally does not move far within the plant.
- Works much faster in bright sunlight.

### Symptoms

- Browning of any part of plant contacted.
- Rapid wilting and death of sprayed tissue.

### Uses

- Stale seedbed, directed sprays in ornamentals and orchards, aquatics, desiccants, dormant application to perennial crops, others.
- Complete lack of soil activity and rapid broad-spectrum activity, plus the fact that they are not easily washed off by rain, make these compounds useful in a number of situations.

## C. FAS\*-INHIBITOR GRASS KILLERS

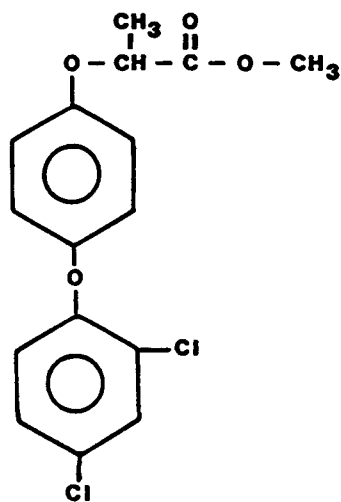

diclofop-methyl (Hoelon)

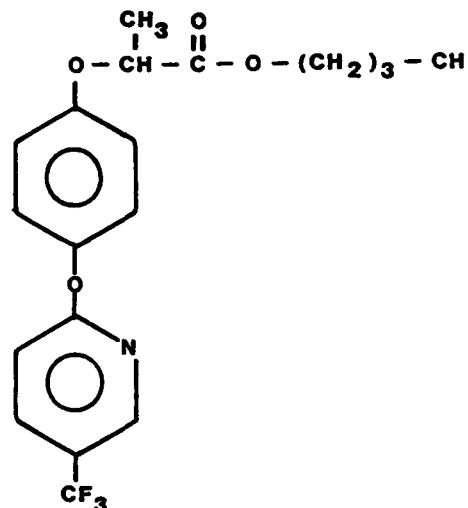

fluazifop-butyl (Fusilade)

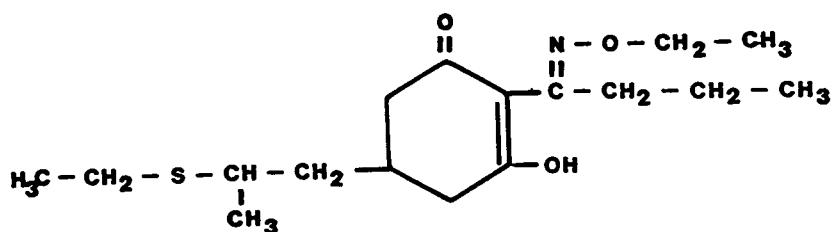

sethoxydim (Poast)

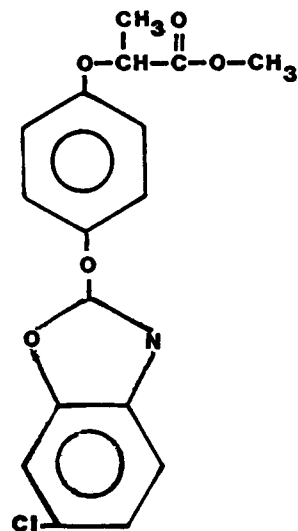

fenoxaprop (Horizon,  
Whip, Tiller, Acclaim,  
Puma, others)

These four herbicides registered for use in Oregon as of 1991. Several experimental herbicides with similar structures from several companies are being studied. A number of these compounds probably will become commercial products in the coming years.

\*FAS = fatty-acid synthesis

## General Characteristics

- Broad-spectrum activity against grasses.
- Hoelon (diclofop-methyl) and Tiller (fenoxaprop) are selective in wheat, most of the others are not.
- High degree of selectivity in nearly all broadleaves.
- Inactive against fine fescues; most give poor control of *Poa annua*, except Select.
- Moderate in mammalian toxicity.
- Soil persistence varies but most are fairly short-lived, some too short-lived.
- Activity on weeds is reduced when mixed with some other herbicides, especially growth-regulator types.

## Mode of Action

- Are translocated in plant, both with water and sugars.
- Recent research shows that these herbicides prevent fatty acid synthesis.

## Symptoms

- Most compounds act very slowly.
- Growth may slow or stop fairly soon, then a general chlorosis, sometimes reddening, develops, followed by general necrosis. Often affects tissue at soil level so one can pluck main stem from crown quite easily.

## Uses

- Hoelon (diclofop-methyl) is used for selective control of wild oats, ryegrass, barnyardgrass, and foxtails in wheat and barley. It is a restricted-use pesticide.
- Hoelon-resistant strains of Italian ryegrass and wild oat have appeared in the Willamette Valley of western Oregon. These strains also are somewhat resistant to other herbicides in this group.
- Fenoxaprop is used in Oregon to help control roughstalk bluegrass in ryegrass. It can also control wild oats in wheat and summer annual grasses in certain types of turf.
- The other compounds are expected to develop wide markets for grass control in many broadleaf crops. Some are already registered for use in fruits, berries, and ornamentals, beans, potatoes, alfalfa, et al.
- Some of the materials will help control bentgrass, German velvetgrass, and other grasses in fine fescue seed fields.

## D. SUBSTITUTED GLYCINE

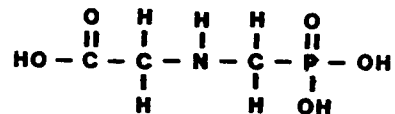

glyphosate (Roundup)  
*N*-(phosphonomethyl) glycine

### General Characteristics

- The isopropylamine salt derivative is very soluble in water.
- Negligible volatility.
- Almost no soil activity.
- Very low mammalian toxicity.

### Mode of Action

- Foliar applied and absorbed.
- Moves throughout the plant with the sugars.
- Best applied to most perennials at bud or early bloom.

### Symptoms

- Slow to appear - general yellowing and browning of large leaf areas, eventually results in an overall death of leaves. Often causes a distinctive orange color in some species, bright red in oats and brome. Symptoms appear more quickly in bright sunlight.

### Uses

- Non-selective - general weed killer, annual and perennial broadleaves and grass.
- Used in both cropland and non-cropland situations. Selectivity is achieved by differential times or placement of the herbicide. Can plant registered crops immediately after application if desired.
- Non-cropland, orchards, perennial weed control between crops, stale seedbed.

Note: Another salt of glyphosate, called Touchdown (sulfosate), is now available for many of the same uses as Roundup (glyphosate). Its characteristics are essentially identical.



## TRIAZINES, UREAS, URACILS

The following three families of herbicides--triazines, substituted ureas, and uracils--are discussed collectively, followed by family-specific information.

### Common Characteristics

1. All are soil applied, but some also have some limited foliar activity.
2. All are taken up by roots and moved in the water stream, but the more water-soluble formulations also have contact activity.
3. All are effective against germinating broadleaf and grass weeds.
4. Nearly all are low in solubility from a formulation standpoint so are formulated as wettable powders, flowables, granules, or dispersible granules. Water solubility ranges from 5 to 3,000 ppm.
5. Most have to be "activated" with water in the soil.
6. Most are selective primarily by rooting depth. Herbicides stay in top layer of soil. Weeds germinating in this layer are killed. Crops with roots below this layer are not exposed to the chemical. Major exceptions are atrazine on corn and Douglas fir and terbacil on mint, whose selectivity is biochemical.
7. All are known to inhibit photosynthesis. Death results from an interruption of electron flow, causing membrane destruction, especially in bright sunlight.
8. None are especially volatile or are photo-decomposed rapidly, so they may remain on the soil surface for some time. In Oregon this probably should not exceed 1 month, less in the summer and early fall.
9. All are soil sterilants at high rates. Most of the more persistent herbicides of these groups can present problems to subsequent crops in the rotation.
10. All have low mammalian toxicity.
11. Symptoms - seedlings generally look green and healthy; then chlorosis begins, either rather general over the leaves or at tips and margins. Can be either veinal or interveinal chlorosis also. Necrosis generally begins at tips and margins of leaves and death of the plant is progressive.

Degree of downward movement in the soil depends on:

- a) Solubility of herbicides within each family.
- b) Adsorption qualities of the herbicide.

## E. TRIAZINES

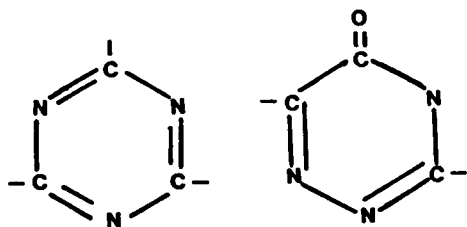

\* s-triazines

\*\* as-triazine

#2 carbon - Cl chloro  
 OCH<sub>3</sub> methoxy  
 S-CH<sub>3</sub> methylthio

\*s = symmetrical

\*\*as = asymmetrical

Example:

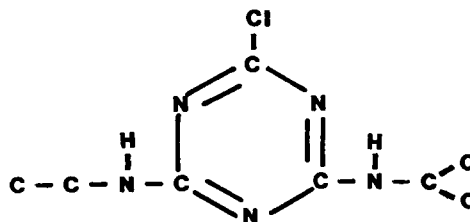

atrazine

6-chloro-N-ethyl-N'-  
 methylethyl)-1,3,5-  
 triazine-2,4-diamine

### Important Herbicides

#### s-triazines

##### -Cl

atrazine (many trade names)

simazine (Princep)

cyanazine (Bladex)

##### -OCH<sub>3</sub>

prometon (Pramitol)

##### -SCH<sub>3</sub>

ametryn (Evik)

prometryn (Caparol)

#### as-triazine

metribuzin (Sencor or Lexone)

Simazine - wet areas because less soluble

2. Croplands - pre and early postemergence  
 Control of seedling grasses and broadleaves

### Mechanism of Selectivity in Corn

(for your interest only)

Corn is selective to the *s*-chloro-triazines by two major mechanisms:

1. In the roots, the -Cl can be replaced by an -OH group, inactivating the herbicide. This is called 'hydroxylation.'
2. In the leaves, the -Cl can be replaced with glutathione, a tripeptide. This is called 'glutathione conjugation'.

### Uses

1. Nonselective - general vegetation control  
 Atrazine - dry areas because more soluble

## F. UREAS

Example:

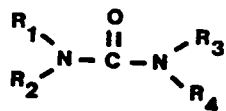

Basic structure

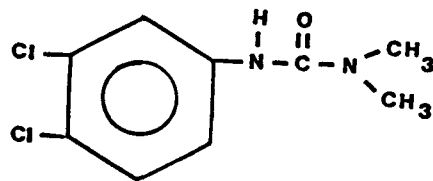

diuron

### Important Herbicides

diuron (several trade names,  
including Karmex)  
linuron (Lorox)  
siduron (Tupersan)

A large number of other urea herbicides are used, especially in Europe.

### Uses

Controls many annual and seedling grasses and broadleaves

#### Non-Cropland

- General weed killer at high rates

#### Cropland

- Selective control at lower rates, depending largely on differences in rooting depth.

## G. URACILS

Example:

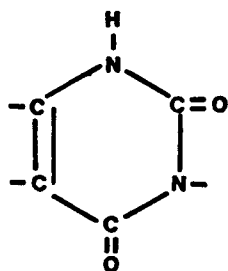

Basic structure

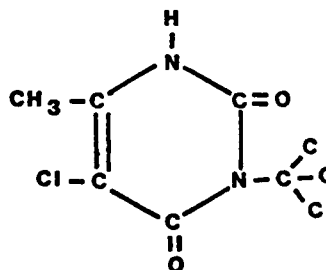

terbacil (Sinbar)

### Important Herbicides

terbacil (Sinbar)

bromacil (Hyvar-X)

### Uses

Controls most annual grasses and broadleaves. Bromacil used for general vegetation control and in citrus. Terbacil used in orchards, mint, and sugarcane.

## H. THIOCARBAMATES (or carbamothioates)

Example:

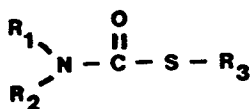

Basic structure

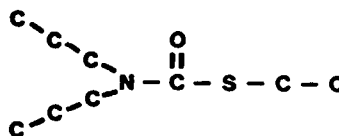

EPTC (Eptam)

### Important Herbicides

EPTC (Eptam)  
butylate (Sutan)  
cycloate (Ro-Neet)  
triallate (Avadex BW or Fargo)  
vernolate (Vernam)  
EPTC + safener (Eradicane)

### General Characteristics

- Soil applied.
- Highly volatile, requiring incorporation immediately after spraying.
- Persistence in soil is short, a few weeks at most.
- Relatively low mammalian toxicity.

### Mode of Action

- Uptake is generally through the emerging shoot of grass seedlings, some root absorption in broadleaves.
- Almost no movement up from the roots with water.

- Inhibitors of meristematic regions, mitotic poison. Probably act by inhibiting fatty acid synthesis.

### Symptoms

- Abnormal growth and emergence of leaves from the coleoptile or just the appearance of the coleoptile with no further growth of true leaves.
- Injured broadleaves show stunting - cupped and "leathery" leaves with necrotic edges.

### Uses

- Annual weeds, especially grass weeds - (some perennials) - and nutsedge in a large number of crops. Especially miss lambsquarters family and mustards. Control of perennial grasses is improved by first mechanically breaking up the rhizome system into small segments.

## I. DINITROBENZENEAMINES or DINITROANILINES

Example:

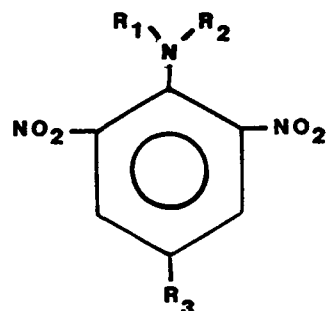

Basic structure

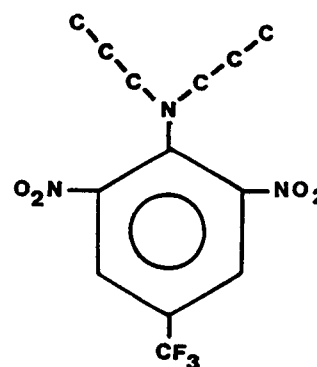

trifluralin (Treflan)

### Important herbicides

trifluralin (Treflan)  
benefin (Balan)  
oryzalin (Surflan)  
ethalfluralin (Sonalan)  
pendimethalin (Prowl)

### General Characteristics

- Soil applied.
- All yellow in color.
- Low water solubility, resistant to leaching.
- Most have high volatility and require incorporation within 24 hours.
- Medium persistence in soils - longer than thiocarbamates, shorter than triazines.
- Very low mammalian toxicity.

### Mode of Action

- Absorbed by emerging grass shoot; both shoot and root of broadleaves.
- No movement within the plant.
- Inhibits growth processes, cell division, etc. Especially active in meristematic tissue.

### Symptoms

- Pruning of secondary roots
- Stunted shoots and leaves

### Uses

- Control of germinating grasses and some broadleaves in many crops; weak on nightshades and mustards. Not effective on most perennial grasses.

## J. SULFONYLUREAS

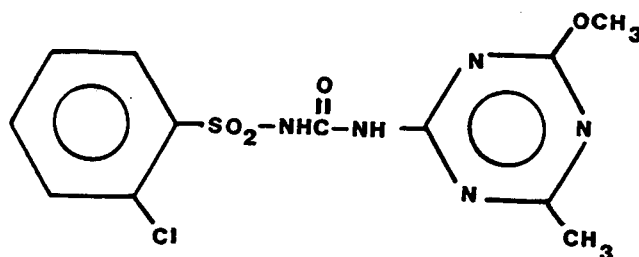

chlorsulfuron (Glean)

### General Characteristics

- Active at low dosages, e.g., chlorsulfuron is used in wheat at 1/8 to 3/8 oz. per acre.
- Some are persistent in the soil, especially in high pH soils.
- Non volatile.
- Very low mammalian toxicity.

### Mode of Action

- Absorbed and translocated from both foliage and soil.
- Inhibits the synthesis of certain amino acids by interfering with a particular enzyme. This causes a rapid decrease in plant cell division.

### Symptoms

- Variable with rate and species. Slow to appear. Include discoloration as mild chlorosis starts in the youngest tissue. In some species, a purpling develops. Necrosis starts in the growing points and progresses to older parts, resulting in plant death.

### Uses

- As new analogues are introduced, usage becomes broader.
  - a. Glean (chlorsulfuron) is used primarily selectively in small grains.
  - b. Oust (sulfometuron) is primarily used for non-crop weed control.
  - c. Classic (chlorimuron) is used selectively in soybeans.
  - d. Londax (bensulfuron) is used selectively in rice.
  - e. Ally (metsulfuron) is registered alone or mixed with Glean for use in small grains.
  - f. Harmony (thifensulfuron) and Express (tribenuron) are short-lived analogues for use in small grains. Combination of the two is Harmony Extra.
  - g. Pinnacle (thifensulfuron) is used in soybeans.
  - h. Muster (ethametsulfuron) is being developed for use in Canada on rape-seed.
  - i. Amber (triasulfuron) is similar to Glean.

j. Accent (nicosulfuron) and Beacon (primisulfuron) are used in corn, mostly for grass control.

- Some weed species have developed populations resistant to sulfonylureas. These include prickly lettuce, Russian thistle, and kochia, perhaps others.

**NOTES:**

- Most of the members of this family are more active on broadleaves but also control a few grass species.

**Some Additional Herbicides and Herbicide Families**

**Miscellaneous**

Cytrol, Amitrole-T (amitrole)  
 AMS (ammate)  
 Avenge (difenzoquat)  
 Basagran (bentazon)  
 Betasan, Prefar (bensulide)  
 Amiben (chloramben)  
 Ronstar (oxadiazon)  
 Des-i-Cate, Herbicide 273, Hydrothol, etc. (endothall)  
 Nortron (ethofumesate)  
 Kerb (pronamide)  
 Krenite (fosamine)  
 Probe (methazole)  
 Devrinol (napropamide)  
 Alanap (naptalam)  
 Solicam, Evital (norflurazon)  
 Destun (perfluidone)  
 Brake, Sonar (fluridone)  
 Pyramin (pyrazon)  
 Ravage (buthidazole)  
 Mylone (dazomet)

**Herbicide Families**

acetanilides  
 imidazolinones  
 organic arsenicals  
 carbamates  
 diphenyl ethers  
 inorganic herbicides  
 benzonitriles  
 dinitrophenols  
 acetamides  
 aliphatic acids

Some of these herbicides are being discontinued, primarily as a result of the re-registration process.



## STUDY QUESTIONS FOR CHAPTER 4

1. How do phenoxy herbicides move through the plant (with sugars or with water)?
2. What type of weeds are growth regulators used to control?
3. What major type of herbicides includes Banvel (dicamba)?
4. Why is Tordon (picloram) a restricted-use pesticide?
5. How toxic are phenoxy herbicides to mammals?
6. What major type of herbicides includes Stinger (clopyralid)?
7. How effective is paraquat through the soil.
8. How toxic are paraquat and diquat to mammals?
9. What type of weeds do the FAS inhibitors control?
10. List three FAS inhibitors.
11. Are most of the FAS inhibitors long-lived or short-lived in the soil?
12. How toxic is Roundup (glyphosate) to mammals?
13. How does glyphosate move in the plant?
14. How active is glyphosate through the soil?
15. How do triazines, ureas, and uracils kill plants?
16. How toxic are those three types to mammals?
17. How do those three types move in the plant?
18. Discuss foliage vs. soil activity, mammalian toxicity, movement in the plant, and persistence in the soil for thiocarbamates, dinitroanilines, and sulfonylureas.
19. Why do most thiocarbamates need to be incorporated into the soil?
20. What herbicide type does each of the following herbicides belong:
  - (a) Glean (chlorsulfuron)
  - (b) Garlon (triclopyr)
  - (c) Eptam (EPTC)
  - (d) atrazine
  - (e) Hoelon (diclofop)
  - (f) Harmony Extra
  - (g) Treflan (trifluralin)
  - (h) diuron
  - (i) Sinbar (terbacil)
  - (j) 2,4-D
  - (k) Banvel (dicamba)
  - (l) Poast (sethoxydim)

## CHAPTER 5

# FACTORS INFLUENCING FOLIAGE-APPLIED HERBICIDES

For a foliage-applied herbicide to be effective, the following chain of events must occur: The herbicide must (1) reach the plant, (2) be retained on the leaf, (3) penetrate the leaf, (4) move to its site of action, and (5) remain toxic long enough to exert its action.

- 1. Reaching the plant.** Reaching the plant seems an obvious requirement for effective herbicide use. However, you would be surprised at how many times this is overlooked in practical field situations. There are at least three ways in which proper amounts of herbicides fail to reach the leaves:

One of these involves spray drift, which is the lateral movement of spray particles (including the carrier). In general, large nozzles designed to dispense coarse sprays and low pressure will reduce spray drift because larger spray droplets are formed. Also, drift retardants may be added to the spray solution to reduce spray drift.

Secondly, volatilization of a material prior to reaching the plant can occur, particularly from aerial applications. This refers to the change of the herbicide from the solid or liquid state into the gas form. Several herbicides are sufficiently volatile that significant percentages could be lost in this way. At this point, it is important to recognize the difference between spray drift and volatility. Volatility

refers to the ability of a chemical to change to a gas; spray drift refers to movement of the spray droplets. People will disclaim any responsibility from spray drift because, they say, they have used a nonvolatile formulation. This is not a strong argument because even nonvolatile materials can drift.

A third way in which a herbicide may be prevented from reaching the target leaf would be by shading from taller plants. We generally refer to this as the "canopy" effect. A common complaint is that a particular contact herbicide fails to work properly because there are many surviving plants. Often, the reason for this is that the herbicide contacted only the top overlying layer of leaf surfaces and failed to reach the smaller plants underneath.

- 2. Retention on the leaf.** Once the herbicide reaches the leaf it must be retained on the surface long enough to be absorbed. Several factors can be involved in retention.

The morphology of the plant has a considerable effect. Whether the leaves are upright or horizontal might determine whether or not the spray droplet remains on the leaf or runs off (Figure 5-1). Also, retention may depend on whether the leaf is waxy or nonwaxy. Extreme examples might be wild garlic vs. mustard. The wild garlic has waxy, upright leaves, while the mustard has broad, horizontal, nonwaxy leaves.

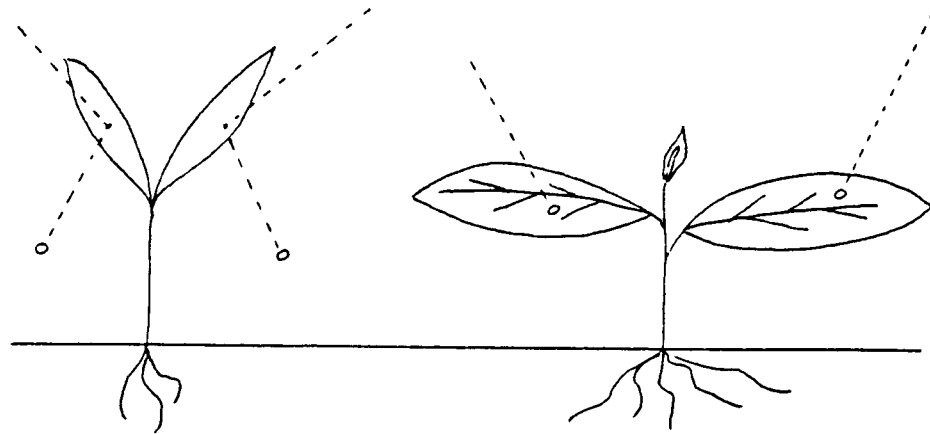

Figure 5-1.

Narrow, upright, waxy leaves, spray runs off.

Broad, horizontal, non-waxy leaves, spray is retained.

The characteristics of the spray solution are important. These can be changed by the inclusion of additives or "adjuvants". These might be adhesives or stickers. Wetting agents often can act as sticking agents when used in low volumes of water. For example, the use of wetting agents are always recommended with paraquat on grasses. Otherwise, retention on the leaves is very poor.

The volatility of the herbicide also may be important. Some materials might evaporate too rapidly for adequate retention time. EPTC (Eptam) might be an effective postemergence herbicide if it were not so volatile.

**3. Absorption into the foliage.** Herbicides can enter the leaves either through the lower or upper surfaces. Usually the lower surfaces are more permeable than the upper sides. The herbicide can penetrate the leaf either through the stomates (pores) or directly through the cuticle. We will discuss cuticle uptake

primarily but remember that uptake also can occur through the stomates.

At least four things can happen to a herbicide once it is applied and retained on the leaf surface:

- a. It can remain on the outside either as a crystal or a liquid. This can happen to many salts when the water carrier evaporates rapidly.
- b. It can enter the cuticle and remain dissolved in the waxy portion. This can happen with various weed oils.
- c. It can enter and move in the aqueous phase along cell walls to the transport system. Examples would include amitrole and dalapon.
- d. It could enter and move directly into living cells and through them to the transport system. The best example of this would be 2,4-D.

Environmental conditions can drastically affect the uptake of herbicides, particularly the water-soluble ones. When relative humidity is high, the spray droplets evaporate less rapidly, allowing more time for the dissolved herbicides to penetrate. Also, the hydrophilic portions (water-absorbing parts) of the cutin and the pectin strands can absorb moisture and become swollen. This forces the wax platelets farther apart and provides a much easier route for the water-soluble herbicides to penetrate. Relative humidity has less effect on oily-type herbicides.

In summary, some important concepts of cuticular absorption are as follows:

- a. Water-soluble and oil-soluble herbicides are absorbed differently.
- b. Cuticle is thicker when developed under dry conditions, thinner under wet conditions. Extremes are cactuses and aquatic plants. This can influence uptake of foliar-applied herbicides.
- c. The chemical properties of herbicides can affect uptake; polar vs. nonpolar, water solubility, etc.
- d. Formulation is important. An emulsifiable concentrate is more readily absorbed than a wettable powder, etc.
- e. Adjuvants such as wetting agents and penetrants can increase uptake, particularly of water-soluble materials.
- f. Good soil moisture assures that the leaves are moist and more able to absorb herbicides.
- g. High humidity conditions can

increase uptake, especially of water-soluble by:

- 1) Reducing evaporation of the carrier from leaf surface, and
- 2) Water-absorbing substances in cuticular layer can absorb moisture, causing the cuticular layer to swell and making the absorption of water-soluble herbicides more available. This swelling also forces the wax platelets farther apart.

**4. Translocation.** Some foliage-applied herbicides are considered contact-type materials, i.e., they kill only the tissue with which they come in contact. However, many important herbicides can move from the point of application to other parts of the plant. These systemic herbicides include such compounds as 2,4-D, amitrole, glyphosate, and many others.

There are two systems of translocation in plants; (a) with sugars formed by photosynthesis in the leaves, and (b) with the water stream, mostly upward from the roots to the leaves.

Sugars move from where they are manufactured (source) to where they are needed (sink). The sinks may be rapidly growing tissue such as growing points on the stem or root or the developing grain. They may be storage areas, such as tubers and bulbs. Herbicides that move in this system -- 2,4-D, MCPA, dicamba, clopyralid, others -- simply follow wherever the sugars move.

Movement of herbicides in the water stream seems to be entirely passive; i.e.,

they are like a wood chip in the river where movement is dictated completely by the water stream.

This means that conditions of optimum water movement, i.e., high soil moisture and low humidity in the air, will favor rapid uptake of herbicides from the soil.

There are varying degrees of partitioning into the sugar or water stream. Some herbicides seem to move entirely in one or the other, but others are able to move in both of these two tissues. Several compounds including 2,4-D, glyphosate, amitrole, dicamba, and picloram can move from the foliage

along with sugars. They will bypass leaves that are producing and exporting sugars.

The phenoxy herbicides seem to move almost entirely with the sugars. Glyphosate can move in both systems but its primary route is with sugars. Several herbicides can move in both systems. These include dicamba, picloram, FAS inhibitors, and sulfonylureas. Several types, triazines, ureas, and uracils, move almost entirely in the water stream. Some herbicides do not seem to move very much at all. These include paraquat, diquat, dinitroanilines, and thiocarbamates.

### MOVEMENT OF CHEMICALS IN PLANTS

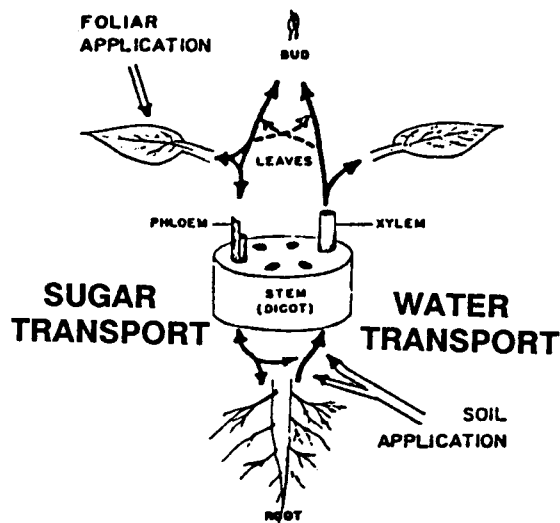
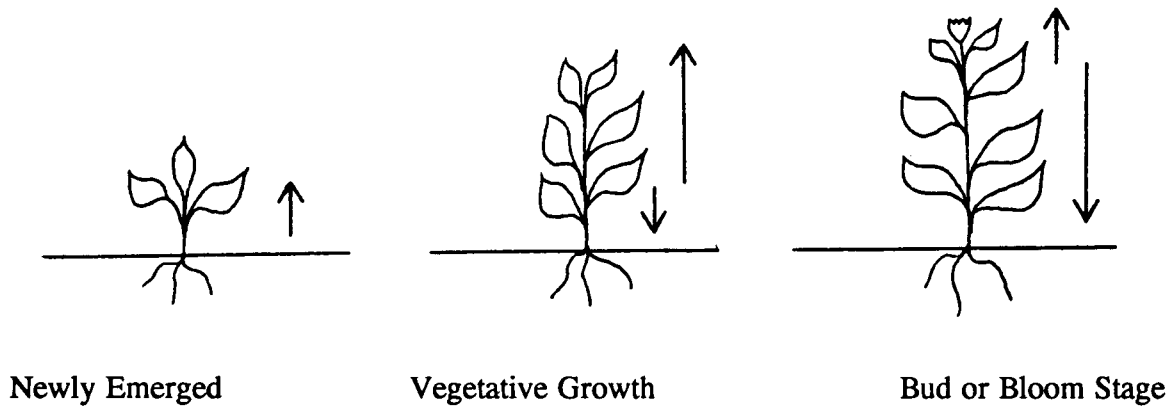

Figure 5-2. The "source to sink" concept is very important here. The sink refers to a site within the plant at which sugars are being used up either to form storage materials or in active metabolism. Sugars tend to move from the areas of the leaf where they were manufactured (source) toward the sinks and in the process can carry 2,4-D and other herbicides along. It is now established that 2,4-D cannot move by itself along these pathways but must depend on sugar movement.

Figure 5-3. Carbohydrate Movement in Perennial Weeds



In annual weeds, translocation over long distances is generally not of major importance compared to other factors influencing effectiveness of the herbicide. In biennials, treatment in the seedling stage or in the rosette stage but before the plant sends up a flower stalk is critical in many species. But in perennials, the source-to-sink concept can be of major importance in timing the spray application. In a plant newly emerged from vegetative parts, most of the sugar produced in the leaves is being used to form new vegetative growth; i.e., movement is mostly upward. When the plant reaches the bud or early bloom stage, vegetative growth slows down or ceases entirely and most of the sugar produced in the leaves begins to move toward underground storage tissue (Figure 5-3).

At this point, application of herbicides is often most effective for long-term control, simply because source-

to-sink movement results in more complete translocation throughout the plant.

Also, creeping perennials regrowing in the fall from earlier disturbance are generally replenishing their root reserves before winter and sending considerable amounts of sugars downward. This often is an excellent time to apply growth-regulator type herbicides or glyphosate for effective movement to the roots.

Translocation of herbicides from the leaves occurs in living tissue, so rapid burning of the leaves and stems can be detrimental to good translocation. This is sort of a case of "burning your bridges in front of you". Therefore, applying our most toxic formulation of a translocated material to perennial weeds may not be the best idea, because this simply kills the tops of the plants too rapidly for good distribution into the roots.

## STUDY QUESTIONS FOR CHAPTER 5

1. What are three ways a herbicide can be prevented from reaching the plant after it leaves the spray nozzle?
2. Compare the ease with which most herbicides could be retained on the leaves of wild garlic vs. wild mustard.
3. Explain why relative humidity might influence herbicide uptake into the leaves.
4. Does humidity have more effect on water-soluble or oil-soluble herbicides? Why?
5. Why might soil moisture be important for uptake into the leaves?
6. What effect do growing conditions have on cuticle thickness?
7. What are the two major systems of translocation within a plant?
8. When during the season is a creeping perennial most likely to be sending sugars to its roots?
9. What does "source-to-sink" mean?
10. Name four "sinks".
11. Name three herbicides that translocate almost entirely with the sugar flow--with the water stream--with either.
12. Why might applying an overdose of herbicide be detrimental to best results?

## CHAPTER 6

### FACTORS INFLUENCING SOIL-APPLIED HERBICIDES

A large number of herbicides are now available on the market that are applied to the soil for uptake by the emerging shoots or by the roots of weeds. Unlike leaves, roots are adapted as absorbing organs and are very effective at taking up the herbicides. However, soil-applied herbicides are not always available for uptake into the plant. A number of different factors affect herbicide availability; these factors include:

#### Microbiological effects

Before discussing the effects of microbes on herbicides, perhaps we should say one brief word on the effect of herbicides on microbes in the soil. This is a question that has not been completely resolved. Most studies show that normal rates of herbicides sometimes will cause a temporary shift in the microbe population but seldom an overall reduction. Any reductions are usually very temporary. Changing the kinds of microbes available in the soil could have a considerable effect. This remains to be investigated more thoroughly, but so far very little detrimental influence of this type has been noted.

Microbes can use herbicides for food. They may also break down a herbicide incidentally, perhaps while working on another food source. At any rate, the breakdown of herbicides in soils by microbes is a highly important phenomenon. Without microbes, most of our herbicides would

remain in the soil indefinitely and could cause serious problems by carrying over from one year to the next.

Some herbicides are decomposed rapidly, i.e. within three to four weeks. This could include compounds such as 2,4-D and EPTC. Some compounds are more resistant to microbial breakdown and can persist even more than one year. These include herbicides such as Sinbar (terbacil), diuron, and atrazine.

In general, any condition that is favorable to the growth of microbes will hasten herbicide decomposition. Temperature, moisture, aeration, organic matter content, pH, minerals present, concentration of the herbicide, species of microbes present, the particular herbicide involved, and preconditioning (soil enrichment) can all be important factors. A warm, moist, fertile soil is generally ideal for breakdown of herbicides. These conditions are not always met. In many areas of the arid west, herbicides are applied to the surface of furrow-irrigated fields. Unless rainfall occurs, the herbicide remains on the dry surface of the soil. Microbes obviously are not active in such a condition and the herbicide not only fails to give good weed control but may persist until the next season and cause crop damage. Even if the herbicide is incorporated into the soil, the upward movement of furrow-applied water can bring it to the surface. Perhaps you have seen accumulations of salts from this process in the tops of ridges in furrow-irrigated fields. This is illustrated in the Figure 6-1.



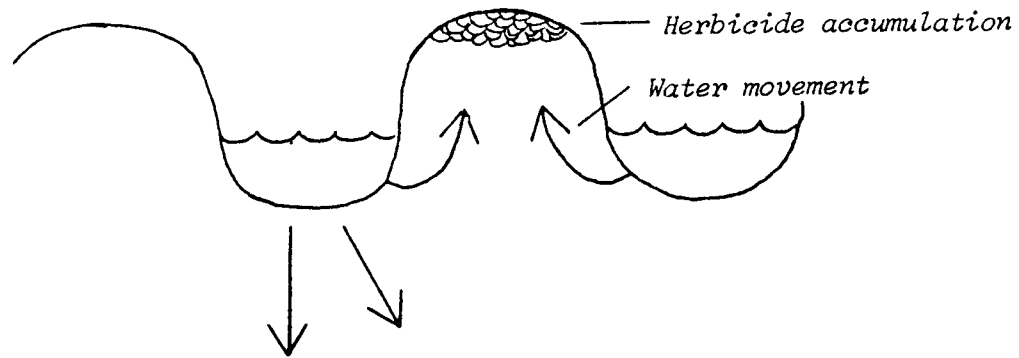
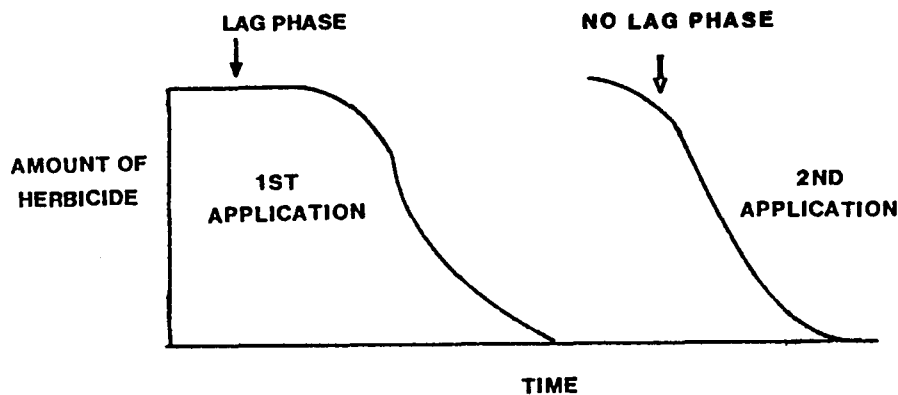

Figure 6-1. Upward movement of water often forces herbicides to the soil surface in furrow-irrigated fields.

**Adaptive breakdown.** Particular strains of microbes that can use a herbicide for food may gain an advantage over other microbes in the soil and therefore increase rapidly in numbers. As the numbers of this particular type of microbe increase, the herbicide is broken down more and more rapidly. This increase in population of such microbes is sometimes termed "soil enrichment". It has nothing to do with soil fertility. When a herbicide is applied to a soil, initial breakdown usually is slow. But as these microbes build up, breakdown occurs much more rapidly. This initial period is called the "lag phase". This is illustrated in Figure 6-2. If the same herbicide is reapplied to that same soil after the first application has disappeared, breakdown will occur much more rapidly and the lag phase may be eliminated completely. This, of course, is because the microbe population has already been built up and is ready to attack the herbicide rapidly. In recent years, some

thiocarbamate herbicides, such as EPTC and vernolate, have become much less effective in certain "problem" soils. This is due to soil enrichment. In studies at Oregon State University, 12 lbs/A of EPTC, a very high rate, has disappeared in less than 2 weeks. Other "adaptive" herbicides include phenoxies, TCA, alachlor, and others.

**Incidental breakdown.** Many herbicides can be degraded by microbes, but the microbes do not appear to be favored in any way. The herbicides simply seem to "get in the way" and are degraded incidentally as the microbes eat other things. The microbes do not build up in population, there is no lag phase, and thus there is no soil enrichment. Herbicides with this kind of microbial breakdown tend to be more persistent in the soil than those that are broken down by the adaptive mechanism. These include the ureas, triazines, uracils, sulfonylureas, and many miscellaneous herbicides.



**Breakdown of soil-applied herbicide by microbes**

Figure 6-2.

### Adsorption on soil colloids

Adsorption (not absorption) is a very important process in regard to soil-applied herbicides. Adsorption refers to the chemical and/or physical attraction of a substance to a surface. When a herbicide is applied to a soil, a considerable percentage of it can be attached to the soil colloids so tightly that the herbicide is unavailable for uptake by plants. This is an equilibrium reaction and as herbicides are removed from the soil solution, more of the herbicide can become desorbed and become available in the soil solution. This is illustrated in Figure 6-3.

The extent to which herbicide adsorption occurs depends to a great extent on the particular herbicide involved. Some

herbicides are quickly and tightly adsorbed (paraquat), while others are adsorbed to a much less extent (sodium chlorate).

There are four primary soil factors that can affect the extent of adsorption. These are:

1. **Texture (sand vs. clay).** Texture influences the extent of adsorption by affecting the surface area available. Clay particles are much smaller than sand particles, so per unit of volume there is much greater surface area available in a clay soil than in a sandy soil. Therefore, herbicides are adsorbed to a greater extent in clays than in sands. Higher rates must be used in clay soils for adequate activity.

2. **Type of clay.** The various kinds of clays can vary in their exchange capacity. Montmorillonite clays have greater exchange capacity and can adsorb larger amounts of herbicide than can illite or kaolinite.
3. **Organic matter content.** This is perhaps the most important soil factor affecting adsorption. More and more research workers believe that organic matter is more important than texture in determining the amount of adsorption. Some soils that are very high in organic matter, such as muck soils or areas around sawmills, have such a tremendous adsorptive capacity that soil-applied herbicides seldom are effective. On the other extreme, some of our desert soils have an organic matter content of less than 1% and great care must be exercised to prevent crop damage since the herbicides are extremely effective.
4. **Soil moisture.** We now know that water can compete with the herbicides for adsorptive sites on the soil colloids. This is illustrated in Figure 6-4. In the case of volatile materials applied to the soil surface, loss is much greater from a moist soil than from a dry soil. The volatile herbicide can be adsorbed more quickly and more completely on the dry soil and is not lost so readily into the atmosphere whereas on the wet soil the water prevents it from being adsorbed and herbicide loss is great. On the other hand, with herbicides that tend to be adsorbed too much for optimum activity anyway and that are not volatile, we may consider it desirable that less of it is adsorbed. For example, when we apply diuron for ryegrass control in wheat, we find that the material is less effective when applied to a dry soil. Results are

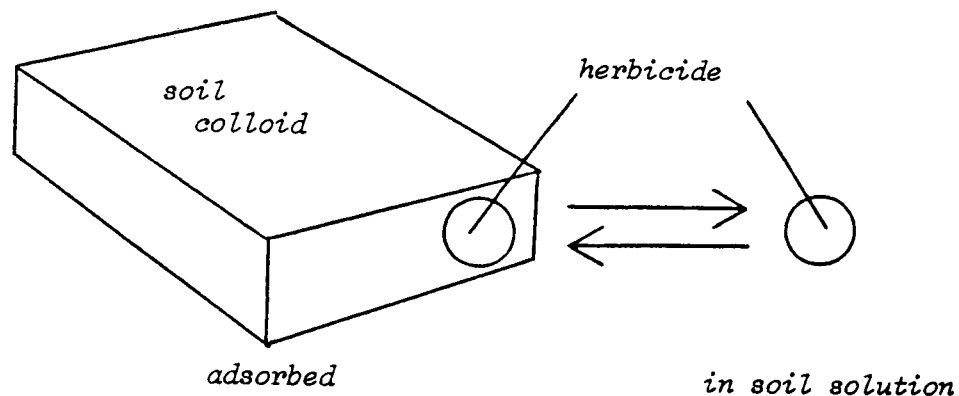

Figure 6-3. Equilibrium process of herbicide adsorption on soil.

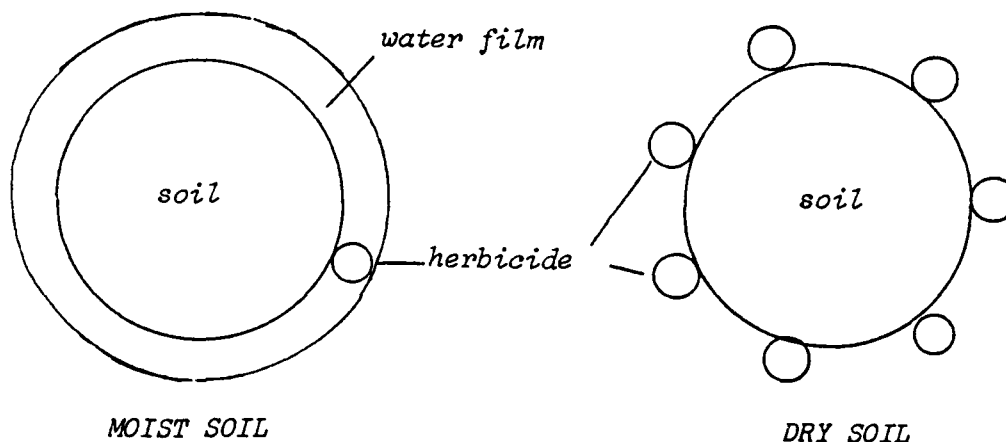

Figure 6-4. Water can compete with herbicides for adsorption sites.

much better if application is delayed until after the soil has been moistened by fall rainfall. The principles are the same in these two cases; we simply want adequate adsorption with slow release in one case and less adsorption in the other case.

### Chemical decomposition

Several chemical reactions can occur in the soil to break a herbicide down. These can be accomplished even in sterile soils where microbes are not a factor. Chemical reactions can include oxidation, reduction, hydrolysis, hydration, and others. An important method of loss of the sulfonylureas is chemical hydrolysis. Hydrolysis of Glean and others is much faster in acid (low pH) soils. In alkaline soils, some of the sulfonylureas may persist in the soil for many years.

### Leaching

Leaching refers to the downward movement of a substance in solution through the soil. The amount of herbicide leaching through the soil depends on its solubility, the volume of water passing through the soil, the distribution of the water, and the adsorptive relationships between the herbicide and the soil. Leaching is more likely from a prolonged period of rain than from intermittent showers, even if the total rainfall is the same. In general, we need some movement of the chemical in order to get it into the soil where it can be absorbed by weed roots. However, we usually do not want the herbicide to move too deeply where it can be ineffective on the weeds and is sometimes injurious to deep-rooted crops.

## Volatility

Some herbicides can evaporate and be lost in the form of a gas or vapor. These materials include such compounds as Eptam, Vapam, Ro-Neet, Treflan (trifluralin), Casoron, and others. Such materials usually need to be incorporated mechanically into the soil immediately after application. Some herbicides are less volatile but can evaporate over a period of time if the environmental conditions are hot and dry. These would include such herbicides as 2,4-D high volatile ester or even atrazine.

## Photodecomposition

Herbicide molecules lying on the soil surface may be able to absorb light without being able to release the energy. In this case the energy is used to break chemical bonds in the molecule and the herbicide is destroyed. Most herbicides are not highly susceptible to photodecomposition, but it can occur over a period of time. The urea herbicides such as diuron are known to be broken down by light when they remain on the soil surface for several weeks. Movement into the soil with rainfall or irrigation will prevent this photodecomposition. Trifluralin, paraquat, and Devrinol (napropamide) are other herbicides known to photodecompose within a few days in bright sunlight. However, trifluralin is quickly incorporated into the soil to avoid evaporation losses, and paraquat has done its herbicidal damage before it is photodecomposed, so photodecomposition is usually not detrimental with these herbicides. Devrinol (napropamide) is the herbicide most influenced by photodecomposition in normal practice.

The soil is a complex medium. Many of the factors discussed above can interact one

with another (Figure 6-5). Any one of the factors can be important enough to lead to success or failure of a herbicide.

Of all environmental factors, soil moisture is likely to be the key factor in the success of soil herbicides. Poor moisture conditions probably cause more failures with soil-applied herbicides than any other single reason. Growers or other managers with sprinkler irrigation have a considerable advantage in the use of soil-applied herbicides since they can assure that the compound can be leached from the soil surface into the rooting zone of the weeds for optimum control. A herbicide lying on the soil surface, unless it is a volatile-type compound, simply cannot do a satisfactory job of controlling germinating weeds. Even if the herbicide has been mechanically incorporated into the soil, unless sufficient moisture is present, the herbicide may not be available for uptake. Weed seedlings emerging from deeper moist soil can emerge through the dry soil layer unharmed. Proper location in the soil and adequate moisture are critical factors.

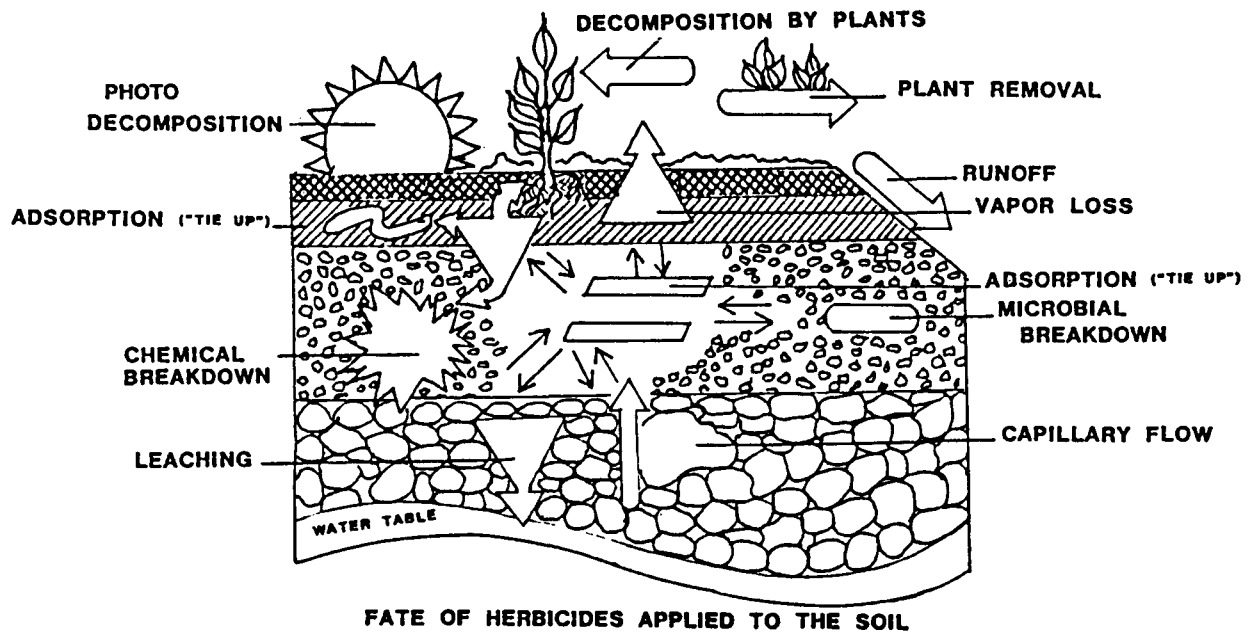

Figure 6-5. Potential fate of a herbicide applied to soil. Note that adsorption can influence most of the other processes. From Martin, A.H. et al. 1977. Herbicide Carryover, Neb. Guide. G74-180. Univ. of Nebraska, Lincoln.

## STUDY QUESTIONS FOR CHAPTER 6

1. List five soil factors which affect microbe action on herbicides. Which do you think are the most important two?
2. What is the difference between "adaptive" and "incidental" microbe action?
3. What does "soil enrichment" mean?
4. What does the "lag phase" refer to?
5. How does pH affect Glean (chlorsulfuron) hydrolysis?
6. What is adsorption? How does it influence the rate of herbicide you use?
7. Name four major soil factors that influence adsorption.
8. How does soil moisture influence adsorption? Would volatile herbicides be more likely to evaporate from wet or dry soils?
9. What does "leaching" mean?
10. What does photodecomposition mean? What are some herbicides that photodecompose? Which herbicide is influenced most?
11. What environment factor is most likely the key factor in success of a soil herbicide.

## CHAPTER 7 APPLICATION EQUIPMENT

While there are many different types, models, and sizes of sprayers, the basic components are still similar: a container to hold the herbicide, and a system to pump it out as a spray. Most sprayers are generally accurate and reliable if properly operated and maintained. However, a thorough

understanding of sprayers is essential for an operator to perform precise, uniform, and economic applications. The following information is intended to be of assistance in becoming more familiar with the components and operation of commonly used sprayers.

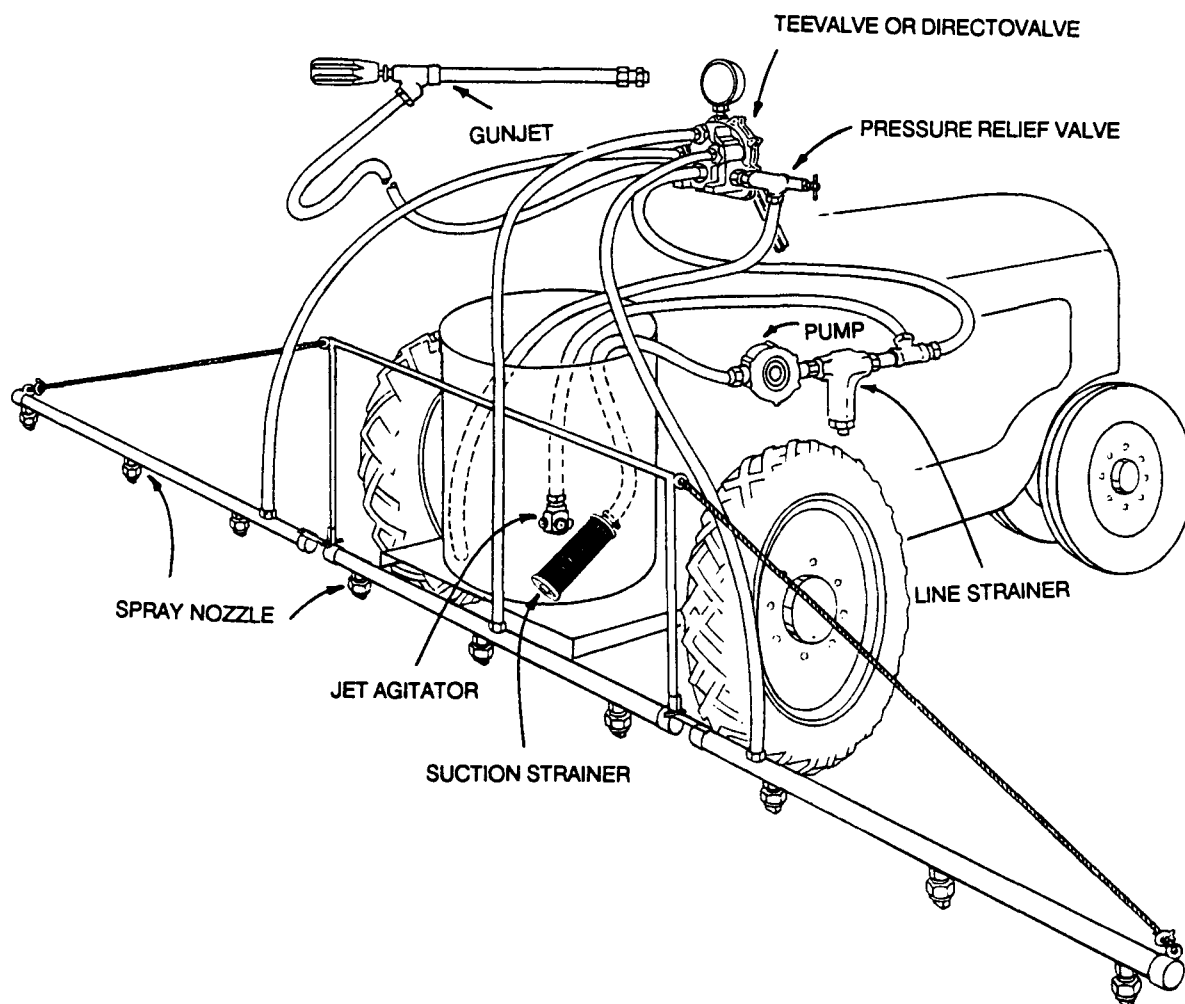

Figure 7-1. A common arrangement of sprayer components.



## TANKS

The ideal tank for a sprayer should be:

- constructed of material (or a combination of materials) that will resist rust and corrosion regardless of the chemical contained;
- formed so that proper agitation of the spray liquid can be obtained easily;
- strong, rigid, and durable to withstand rough usage in the field;
- relatively lightweight;
- fitted with a splash-proof filler opening, at least 12 inches square and incorporating a removable coarse screen filter;
- constructed so as to be easily drained and cleaned;
- low in cost.

Ordinary steel, stainless steel, plastic-coated steel, plastic reinforced with fiber glass, and aluminum alloys are the most commonly used materials for sprayer tanks at present. Ordinary steel tanks lack rust and corrosion resistance; hence, they are inferior to the other materials, but generally are also less expensive. Operators also must be extremely careful not to break the plastic coating on a plastic-lined steel tank.

Sprayer tanks should be equipped with a coarse screen (Figure 7-2) in the filler opening to prevent large lumps of wettable powders or foreign matter from entering the tank and possibly fouling the pump or blocking the nozzles.

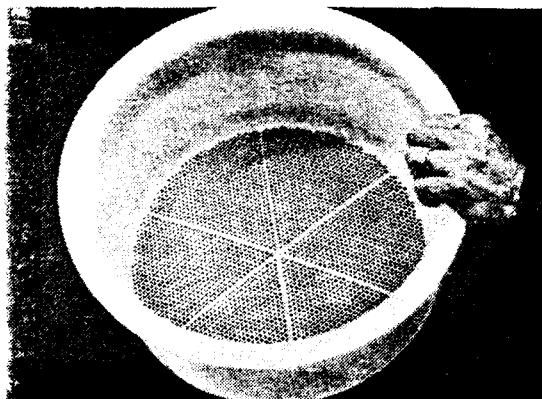

Figure 7-2. Filler screen.

## AGITATION

Thorough, continuous agitation of the spray material in a sprayer tank is essential to ensure concentration uniformity of the chemical being applied, regardless of the liquid level in the tank. The amount of agitation required varies with the shape of the tank and the type of chemical used.

- **Effect of tank shape:** The spray material in the tank can be agitated either hydraulically with spray material from the by-pass line being ejected from a nozzle emersed in the tank, or mechanically with a series of paddles on a shaft. If the tank has a flat bottom, the spray material in the tank will require 30 to 40 percent more agitation than the spray material in a round-bottom tank.
- **Agitation of chemicals in solution:** No agitation is required for soluble herbicides once complete mixing is assured.
- **Agitation of emulsions:** Chemical emulsions can be agitated satisfactorily

by the overflow from the pressure regulator. The by-pass line should carry 10 to 15 percent of the boom output (approximately 1/2 - 3 gpm) when the nozzles are operating. The by-pass line should deliver the liquid to the bottom of the tank (NOT the top) for most effective agitation and the least amount of foaming in the tank. Most modern sprayers are equipped with a hydraulic agitator line in addition to the by-pass line.

- **Agitation of chemicals in suspension:** Mechanical agitation provided by a shaft with one or more paddles on it provides adequate agitation for wettable powders when used with a suitably shaped tank. Many sprayers cannot be conveniently equipped with a mechanical agitator. The by-pass line from the pressure regulator will not supply a sufficient volume of liquid to keep the wettable powder in suspension in the tank. Since 3-6 gpm are required to keep the wettable powder in suspension, an agitator line connected to the pressure side of the pump is essential. This line should deliver the liquid to the bottom of the tank. If an "agitator nozzle" (Figure 7-3) is attached to an agitator line, the effectiveness of this method of agitation is increased. Do not attach these nozzles to, or restrict the flow of liquid in, the by-pass line.

## SUCTION STRAINERS

A suction strainer or screen (Figure 7-4) is placed in the sprayer system to filter out scale and rust flakes as well as other debris in the sprayer tank, thereby protecting the pump. The strainer should have a 100-mesh monel or stainless steel screen when chemicals in solution or emulsions are used.

A 50-mesh screen should be used with wettable powders. The greater the surface area of the screen, the greater is its filtering capacity. A suction strainer with a large filtering capacity will not plug as frequently as one with a small filtering capacity.

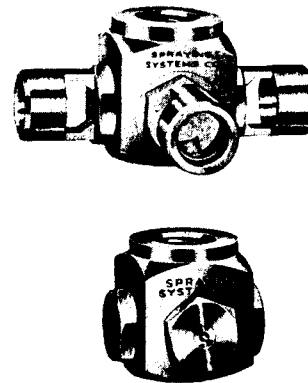

Figure 7-3. Agitator nozzles.

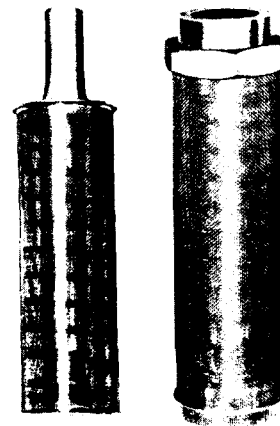

Figure 7-4. Suction strainers.

## PUMPS

The ideal sprayer pump should deliver the required volume of spray material at the required pressure AND have a long life no matter what material it is pumping. It should also be dependable, easy to maintain, corrosion resistant, and inexpensive. Unfortunately, most pumps available for sprayers today cannot fulfill all of these desires nor be considered ideal pumps.

The capacity (in gpm) of a new sprayer pump is affected by the speed at which it is operated as well as the pressure against which it is pumping. As the pump speed is increased, the capacity of the pump increases. As the pressure against which the pump is working is increased, the capacity of most pumps decreases.

Most pump manufacturers have a pump performance table in their advertising literature showing the effect of pump speed and sprayer pressure on the capacity of the pump. These tables must be consulted to compare the capacity of one pump with another, since there is no standard pump speed or sprayer pressure.

**WARNING--Never operate a sprayer pump at speeds or pressures above those recommended by the pump manufacturer.**

There are two general types of pumps used on weed sprayers--the positive displacement and nonpositive displacement. Most weed sprayers currently use a positive displacement pump.

**Positive displacement pumps.** There are five kinds of pumps in this category.

- **External gear pump:** This type is the lowest priced pump of the group, but only one or two brands are available with the capability of handling abrasive

wettable powder suspensions. Otherwise, all brands are satisfactory for pumping chemicals in solution, provided they have sufficient capacity to supply all nozzles on a boom as well as the extra liquid required for agitation in the tank.

- **Internal gear pump:** These units are in the same price range as the external gear pumps. Some internal gear pumps are made of sufficiently durable materials to adequately handle wettable powder suspensions.
- **Roller pump:** The roller pump (Figure 7-5) may be the most commonly found sprayer pump. The pump's 5, 6, 7, or 8 rollers are either nylon or a rubber material. The latter are more expensive than nylon, but are considered to be more durable when abrasive wettable powder suspensions are pumped. Replacing rollers does not always restore a pump to its original condition as wettable powders may cause wear in the pump housing and/or the roller grooves in the pump rotor. Activated carbon is too abrasive for roller pumps.

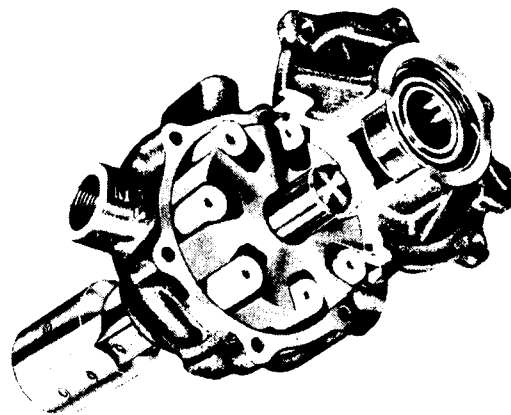

Figure 7-5. Roller pump.

- Piston or plunger pump:** For many years, this type of pump has been used successfully in orchard sprayers. Several brands of PTO-driven (power take-off driven) piston pumps are available. Generally, piston pumps, particularly those with nylon fabric or leather piston cups instead of metal piston rings, are abrasion-resistant and can handle wettable powder suspensions satisfactorily. Piston pumps are available with 1, 2, or 4 cylinders, and most models have an air chamber incorporated in the pump casting. This air chamber tends to smooth out the surges in the pressure lines and stop the pressure gauge needle from jumping. If the pressure gauge needle jumps so that it cannot be read, a separate air chamber or surge tank should be installed on the pressure side of the pump. This type of pump is capable of operating at higher pressure than most other pumps.
- Diaphragm pump:** Because the liquid being pumped does not come in contact with any moving metal parts (except the pump valves), diaphragm pumps are considered to be abrasion resistant. It is important to consult the manufacturer's recommendations before using a new chemical since some chemicals may cause the diaphragm to deteriorate rapidly. The diaphragm pump is usually sold with a separate air chamber since the pump itself may not have one.

**Nonpositive displacement pumps.** The only type of PTO sprayer pump in use that does not displace liquid positively is the centrifugal pump (Figure 7-6). Since the liquid is not positively displaced, a pressure regulator does not have to be used with this

type of pump. However, incorporating a pressure regulator has been found to facilitate changing the application rate. Centrifugal pumps must be operated at high speeds to obtain the capacity necessary for a sprayer. The single impeller (single stage) of the centrifugal pump may be run at 3,000 to 6,000 rpm by means of a pair of gears while the PTO shaft is turning at 540 rpm. Since the centrifugal pump does not displace the liquid positively, the pump must be mounted below the water level in the tank, or a priming system needs to be built in to prime the pump. Centrifugal type pumps will allow more abrasion and passage of larger solids without serious detrimental effect to the operation of the pump.

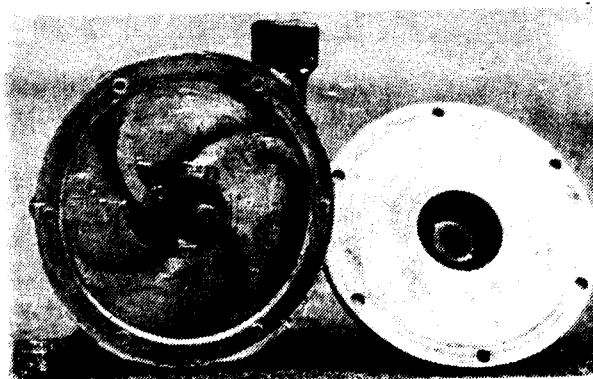

Figure 7-6. Centrifugal pump.

## **A COMPARISON OF SPRAYER PUMPS.**

### **PISTON PUMPS**

#### **Advantages**

- Wear resistant
- Handle suspensions well.
- Good priming characteristics in 1- gpm models and larger.
- High pressure capability.
- Positive displacement.

#### **Disadvantages**

- Cost is approximately double that of comparable roller pumps.
- Pulsation must be controlled by surge tank.
- Generally, the pump size and weight limits direct PTO mount to 10 gpm models.

For the professional sprayer, a piston pump can be the best investment. Piston pumps will cover a great variety of materials and a wide range of pressures. Larger sizes, such as the 20 and 25 gpm models, will cover most spraying needs. Although high priced compared to the other types of pumps in this capacity range, the overall life of piston pumps makes them economical for anyone demanding a rugged job.

Not normally recommended for liquid fertilizer pumping unless specifically made for this purpose.

### **ROLLER PUMPS**

#### **Advantages**

- Low initial cost.
- High output in gpm compared to size.
- Good priming characteristics.
- Low cost, simple repair; give good life when handled properly.
- Available in Ni-Resist for corrosion resistance.

#### **Disadvantages**

- Sensitive to sharp, coarse abrasives, such as sand, barrel scale, activated carbon.

Roller pumps have gained in popularity because of convenience, cost, and efficiency. When used with proper care, they are lowest cost for general sprayer service.

## **GEAR PUMPS**

### **Advantages**

- Self priming.
- Positive displacement.
- Moderate cost.

### **Disadvantages**

- Spur gear bronze pumps are sensitive to suspension materials.
- Rather large models must be used for good output at PTO speed. A 1" spur gear pump has same output as a 6-roller nylon roller pump.
- Maintenance: lower cost models not economically repairable.

Recommended primarily for handling oil and corrosives rather than abrasive materials. Satisfactory for many liquid spray chemicals.

## **CENTRIFUGAL PUMPS**

### **Advantages**

- Handles suspensions well.
- High capacity.
- Rotary mechanical seal can be varied for different uses.
- Needs no relief valve; can use globe
- Simple maintenance.

### **Disadvantages**

- Low pressure: 40 psi is normally the maximum pressure.
- No priming capacity on straight centrifugals. Must have positive suction head or be primed with foot valve.
- Easy to vapor lock unless carefully mounted and air bleeder valve used.
- Must run at high speed; the cost of a gear box or belt drive to drive from PTO is relatively high. valve for by-pass.
- Not positive displacement.

Although higher in purchase cost compared to roller pumps, centrifugal pumps can be lowest in terms of overall cost, providing pressure limit is satisfactory.

**NEVER** operate any positive displacement type of pump without a by-pass pressure regulator.

**NEVER** allow a sprayer pump to run dry. Rollers, seals, and/or bearings may be severely damaged .

## LINE STRAINERS

Most sprayer systems include a line strainer (Figure 7-7) to ensure that no small foreign particles reach the pressure regulator and impair its functioning. Monel screens in line strainers should be 100-mesh for chemicals in solution, or 50-mesh for wettable powder suspensions. 50 mesh means there are 50 openings per linear (not square) inch.

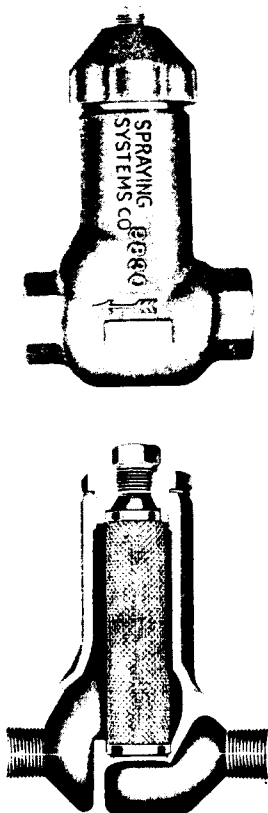
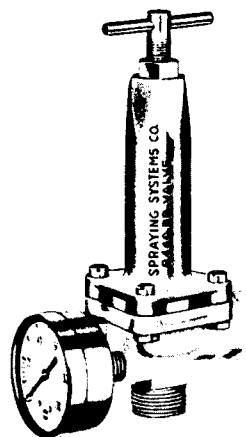

Figure 7-7. Line strainer.

## PRESSURE REGULATORS

One of the smaller but critically important elements of a sprayer system is the pressure regulator or pressure relief valve (Figure 7-8). It serves several key functions:

- control of spray pressure and thus the amount of spray delivered by the nozzles;
- protection of pump seals, hoses, and other parts of the system from damage from excessive pressure, and;
- routes excess spray liquid into the by-pass line that returns to the tank.



Figures 7-8. Pressure regulator.

There is no substitute for a spring-loaded pressure regulator. A water tap will not work and should never be used. When selecting a pressure regulator, be

certain that the capacity of the regulator matches that of the pump being used. The regulator should be located close to the operator so that the pressure can be adjusted conveniently whenever necessary.

**Plunger type.** The plunger may be brass or a stainless steel ball. The spray material, on its way into the by-pass line, comes in contact with the pressure control spring. This may cause the pressure control spring to become gummed up or corroded when some wettable powders are used. The brass plunger, since it has spray material flowing past it, is rapidly worn by wettable powder suspensions.

**Diaphragm type.** This type of pressure regulator is more expensive than those using plungers. Usually the parts of a diaphragm pressure relief valve that are in contact with spray liquid are durable as well as easily replaced.

If sprayer pump capacity is too high for the pressure regulator, the regulator may be damaged and/or overloaded when the boom is shut off. An unloader valve, specifically designed to protect the pressure regulator and pump, should be added to the sprayer system. These valves are available from most sprayer manufacturers either as a separate item or in combination with the pressure regulator.

## PRESSURE GAUGES

The reading on a pressure gauge (Figure 7-9) is essentially the heartbeat of the sprayer. Without this information, the operator is unable to judge whether the system is performing properly. When pressure varies, the amount of liquid coming out of the nozzles varies. Gauges

are commercially available that indicate 0-60 psi; 0-100 psi; 0-300 psi--up to 0-1,000 psi pressure. If the gauge needle jumps excessively while the sprayer is operating, a surge tank should be added to the sprayer system, a damping device may be added to the gauge, or the gauge should be replaced with one of less sensitivity. The gauge should always be mounted so that the operator can see it easily. If there is any question about the accuracy of the gauge, have it tested.

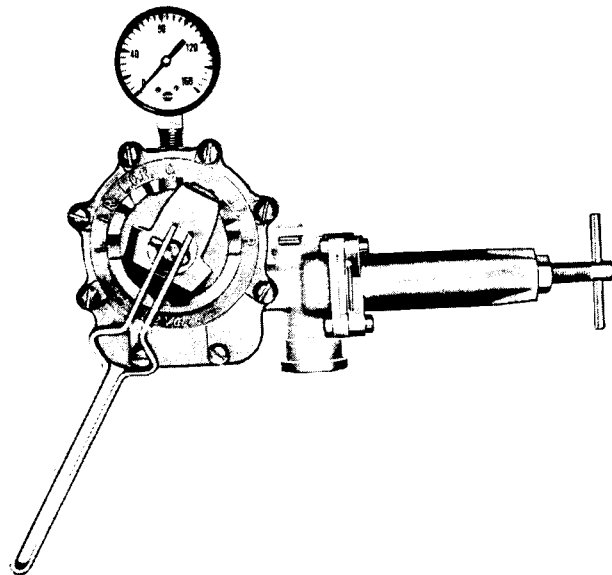

Figure 7-9. Pressure gauge and selector valve.

## SELECTOR AND SHUT-OFF VALVES

This equipment (Figure 7-9) allows the operator to conveniently select one, two, or three sections of the boom for spraying a narrow strip in the field, or shut off all sections of the boom quickly and easily at the end of the field. The shut-off valve should always be closed at the end of the field to avoid excessive application of chemicals on headlands and to reduce the possibility of drift. The selector valve casting usually has a removable plug in it.



The gate valve and piping necessary for spot spraying can then be installed.

## HOSES

A chain is only as strong as its weakest link, to coin a phrase. The hoses used in sprayer systems can be that weakest link. High quality hose and fittings can be expensive; garden hose, while less expensive to purchase, will not last long and often will burst when used with high pump pressures. The manufacturers of hose specify maximum pressure that can be applied safely. It is best to use hose that will withstand the maximum pressure that the sprayer pump will supply.

## BOOM SPRAYING

Early weed sprayer booms were made of either galvanized or black iron pipe. Iron pipe is heavy, and even when it is galvanized, it is a constant source of flakes of rust that plug nozzles. Recently, sprayer booms have been made from copper tubing, aluminum tubing, or rubber hose that is adequately supported by angle iron (Figure 7-10). Even though these materials are rust resistant, the end of the boom should be equipped with a removable plug for easy cleaning.

Sprayer booms are commercially available in lengths of 15 to 60 feet or more. Even with a 20-foot boom, it is essential to have some means of protecting the boom from damage if a tree or other obstacle is encountered. The most common boom is made in three sections--one rigid section in the middle of the machine, and two folding sections, one extending out on each side. These outboard sections are hinged at their inner

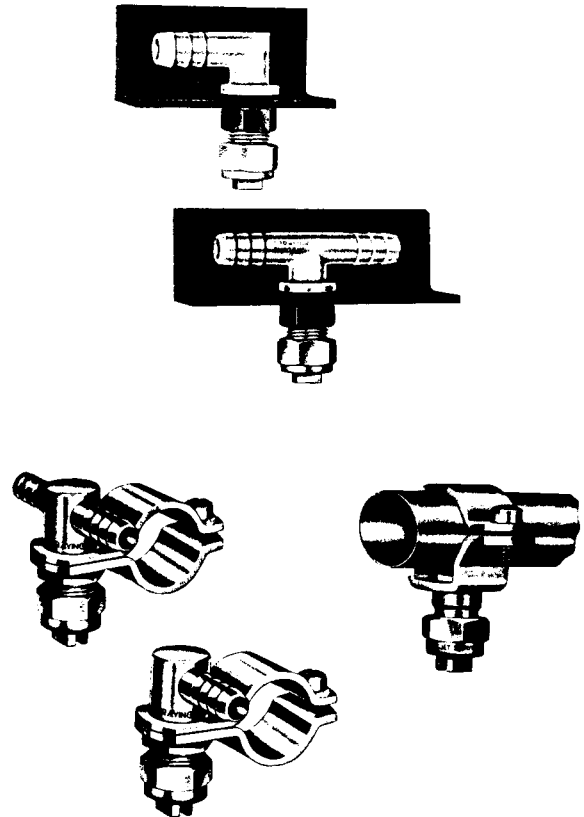

Figure 7-10. Nozzle bodies for three types of spray boom.

ends and are supported from the center of the machine by a rope, light chain, or brace, or by wheels at the end of the boom.

This type of construction provides adequate support for a 20- to 35-foot boom, offers the versatility necessary in irregularly shaped fields, and gives a sprayer the mobility required when moving through narrow gateways.

The height of the sprayer boom should be easy to adjust so that the nozzles can deliver the chemical uniformly. Boom supports should be arranged so that the boom can be set at any height from 12 to 48 inches above the surface being sprayed.

If a system will be used to apply directed sprays in row crops, select a boom with adjustable nozzle spacing. The sprayer can then be converted easily from an overall sprayer to a row-crop sprayer by merely adding the required drop pipes at the proper intervals.

## DIRECTED SPRAYING

Some herbicides may damage the crop if applied at certain stages of crop growth, but can be used to control weeds if special nozzle arrangements are used. The use of drop pipes (Figure 7-11) allows the spray to be directed onto the weeds under the crop leaves. Drop pipes must be mounted so that they are midway between the crop rows. This makes it possible to arrange nozzles on a swivel or on a cross pipe so that the spray is directed under the crop leaves.

Drop pipes should not be attached rigidly to the boom; there should be a short section of rubber hose near the top of the drop pipe to prevent breaking the pipe, or the boom, if the ground surface, or some obstacle, is struck. However, to ensure that the nozzles remain in their proper position in relation to the crop rows at all times, the movement of the nozzles must be limited by a coil of wire around the section of hose, or a spring, or some other such device. Rather than support the nozzles directly from the boom, it may be advantageous to support the nozzles on skids (Figure 7-12). A skid arrangement keeps the nozzles the same distance from the ground at all times, and ensures that a minimum amount of herbicide comes in contact with the crop. When the nozzles are supported from the ground, the width of the band sprayed by each nozzle is constant and crop damage is minimized, especially in rough fields.

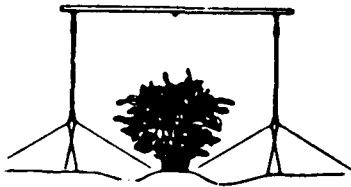

Figure 7-11. Drop pipes for directed spraying.

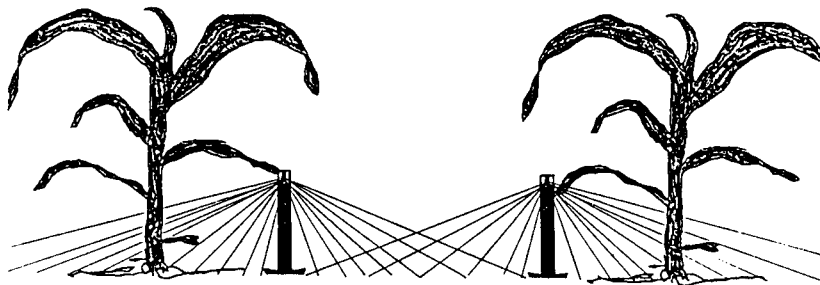

Figure 7-12. A sprayer showing side view of nozzle arrangement (top) and diagram of spray pattern and nozzle placement (bottom) for directed spray. From Kleppe & Harvey, 1991. *Weed Technol.* 5:185-193. By permission from Weed Technology.

For directed spraying to be performed properly, the crop should be uniformly tall and the soil surface should be relatively smooth.

## BAND SPRAYING

When herbicides are considered to be too expensive to apply to the entire field, they are often applied in bands over the row (Figure 7-13). The herbicide should be applied in the band at the same application rate (in gpa and active material per sprayed acre) as recommended for overall spraying. The cost reduction is obtained because only a portion of the field acreage is sprayed.

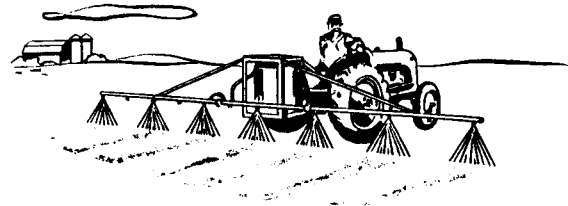

Figure 7-13. Band spraying.

Band spraying nozzles (80-degree even-spray nozzles) are usually mounted on a planter so that the row can be kept exactly in the center of the herbicide band. A tractor equipped with saddle tanks and the necessary sprayer parts is adequate for band spraying.

forward speed of the sprayer and the spraying pressure are known.

## NOZZLE BODIES

A complete nozzle assembly consists of the body, screen, cap, and tip or orifice plate (Figure 7-14). The function of the nozzle body is to attach the screen and tip to the boom. There are several different nozzle body designs available, each with some advantages for certain specific spraying jobs. All designs perform the nozzle body function adequately.

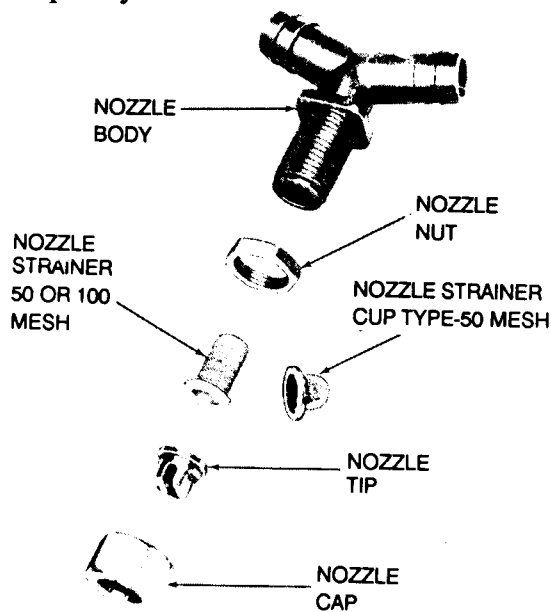

Figure 7-14. Nozzle assembly.

## NOZZLE TIPS

A nozzle is an atomizing device that spreads liquid droplets in a definite direction to form a spray pattern. Since there are a variety of spraying requirements, nozzles consequently are manufactured with a wide variety of replaceable tips or discs. Manufacturers of sprayer nozzles can supply data sheets indicating delivery rates (usually in gpm) at different pressures for their nozzles. The application rate CANNOT be specified on these data sheets unless the

**WARNING--Never operate nozzles at high pressures to compensate for selecting the wrong nozzle size. Unnecessarily high pressures increase the rate of nozzle wear and the drift hazard.**

Nozzle tips and discs are made from many different materials--aluminum, brass, ceramic, plastic, stainless steel, and hardened stainless steel. Each material has advantages and disadvantages.

Aluminum and brass nozzles are the least expensive and are satisfactory for spraying solutions and emulsions, but are least resistant to abrasive materials. Stainless steel nozzles are corrosion-resistant and 2 to 3 times more resistant to abrasive materials than brass or aluminum, but are also more expensive. Hardened stainless steel is not as corrosion-resistant as regular stainless steel, but 10 to 15 times more durable than brass. The cost of hardened stainless is only about 4 times that of brass.

**NOTE--When using any nozzle for spraying wettable powders, the sprayer must be calibrated frequently because as a nozzle wears, the quantity of spray material delivered INCREASES.**

Nozzles are classified according to the spray pattern they emit.

**Fan or flat pattern nozzles.** The spray droplets emerge in a fan shape on leaving the nozzle orifice. Viewed from the side, the fan is flat (Figure 7-15). The orifice shape is elliptical. The spray pattern "tapers" at the edges; i.e., less herbicide is applied at

the edges of the pattern to compensate for approximately 30% overlap of the spray from adjacent nozzles on a boom. This style of nozzle is best suited for spraying herbicides because:

- when a series of these nozzles is properly mounted on a boom, the spray material is more evenly distributed than it would be with any other type of nozzle;
- the flat pattern nozzle delivers droplets in the small-to-medium range at 30-40 psi pressure that do not drift excessively.

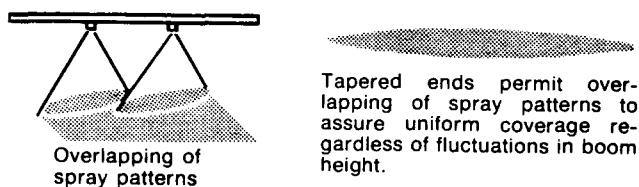

Figure 7-15. Front edge view of flat fan nozzle.

The most commonly used flat pattern nozzles have a 65, 73, or 80° spray angle at 40 psi pressure. In general, for most herbicide spraying done with a relatively short boom (20 to 35 feet), the 80° flat pattern nozzle appears to be the best.

This nozzle makes it possible to keep the boom relatively low, thus reducing the drift hazard while giving a uniform distribution of spray material over the entire length of the boom.

Special flat pattern nozzles, usually called "even spray" nozzles, are available for band spraying of row crops (Figure 7-16).

These nozzles should not be used on spray booms if a uniform distribution of herbicide is required.



Figure 7-16. Spray pattern of flat fan even nozzle.

**Flooding fan or flood jet.** The pattern of the flooding fan nozzle (Figure 7-17) is similar to the fan nozzle, but has a much wider angle (115° or 147°, depending on nozzle size). Droplet size is larger so distribution is poorer. This nozzle is commonly used by commercial herbicide applicators. They often compensate for poorer distribution by using enough nozzles on the boom to allow double coverage, or by spraying the field twice, or both.



Figure 7-17. Flooding fan nozzle.

## NOZZLE SCREENS

A screen is placed behind the nozzle tip (in the nozzle body) to help eliminate, or at least reduce, the frequency with which the nozzle orifice becomes plugged. The size of the nozzle opening and/or the type of chemical being sprayed dictate the size and type of nozzle screen that should be used. For most general herbicide spraying, except the application of wettable powder suspensions, use a 100-mesh monel or

stainless steel nozzle screen. Use a 50-mesh screen when wettable powder suspensions are being applied.

When spray flow to a boom must be turned off frequently in small fields, or when a crop may be damaged by an overdose of chemical, "dribble" from nozzles may be a serious problem. Nozzle dribble occurs after flow to the boom is shut off at the selector valve. The use of a nozzle screen incorporating a check valve (Figure 7-18) will help to eliminate nozzle dribble without otherwise affecting the operation of the sprayer. Some care must be taken to make certain that the ball bearing in the valve does not become jammed or that dirt or chemical particles do not hold the ball bearing off its seat.

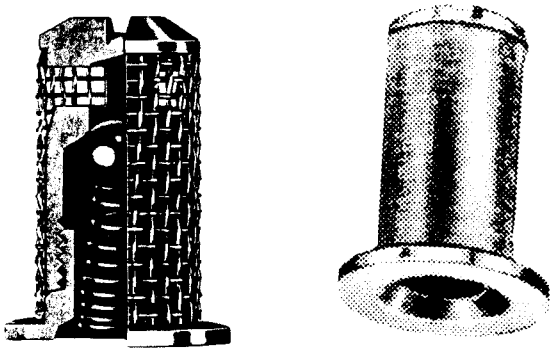

Figure 7-18. Nozzle screens with and without check valve.

## OPERATION OF EQUIPMENT

### SPRAYER OPERATION

A combined operating and safety check should be made prior to starting spraying

operations. The tank should be inspected for cleanliness and absence of foreign matter. Check all hoses, connectors, and clamps to determine the presence of damage or leakage. All strainers and filters in the system should be clean. And finally, each nozzle should be checked to make sure that all are the same size, that none exhibit excessive wear, and that all are properly aligned (Figure 7-19). Overlapping flat fan nozzles, when used, should be set at a slight angle so that spray patterns do not interfere with each other.

Accurate application of spray requires calibration of the sprayer. But before a sprayer can be calibrated, several decisions must be made concerning the most desirable nozzle size and angle, operating pressure, travel speed, and height of boom above the surface to be sprayed. Two factors to consider in making these decisions are spray drift and volume of water (or oil) carrier per acre. It is desirable, if not mandatory, to minimize spray drift. The volume of carrier depends on the type of herbicide, availability of water, and amount of foliage being sprayed.

**Nozzle size.** The size of the orifice in the nozzle directly affects droplet size, which in turn affects the amount of spray drift (smaller droplets mean more drift). As orifice size is increased, the volume of carrier is increased (and droplet size increased) if pressure and speed are constant. A compromise nozzle size is usually necessary to obtain acceptable droplet size without an excessive volume of carrier.

**Nozzle angle.** A wider angle will allow a lower boom height which means less exposure of the spray to wind. Narrow angle nozzles are used when the boom is

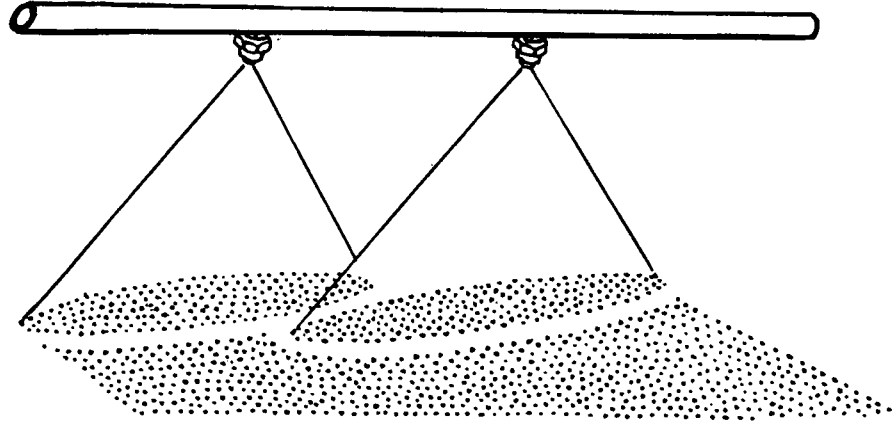

Figure 7-19. Proper alignment of nozzles.

operated at a high setting to avoid growing plants, or when the terrain is very uneven.

**Pressure.** The pressure of the spray material at the nozzles is controlled by the pressure regulator. If, for any reason, the pressure changes, the application rate will then change, but not in direct proportion. The relative change in delivery is proportional to the square root of the relative change in pressure at the nozzle. In order to double the output, the pressure must be increased fourfold. Along with orifice size, pressure determines droplet size; higher pressures produce more small droplets with greater risk of drift.

**Sprayer travel speed.** Variations in travel speed change the number of gallons of material applied to the area being sprayed. Doubling forward speed cuts in half the time nozzles have to spray material on an acre; the application rate, in gallons per acre (gpa), is then cut in half.

The importance of maintaining a constant forward speed, uphill or downhill,

in soft soil or hard, cannot be overemphasized.

Many tractors are now equipped with a speedometer. Unfortunately, the tractor speedometer does NOT indicate the exact forward speed if there is any drive wheel slippage. A low-speed farm speedometer, available at many automotive supply stores, is a useful addition to any sprayer. This type of speedometer can be driven from a front tractor wheel or a wheel of the sprayer. Constant forward speed can be maintained, even when spraying hillsides, using this farm speedometer.

**Boom height.** The distance between the surface being sprayed and the boom is boom height. The angle and spacing of the nozzles used determine boom height. To help reduce spray drift hazard, the boom should be set as close to the surface being sprayed as possible while allowing uniform coverage of weeds, crop, or soil. Since flat fan and flood nozzles are designed to provide an overlapping pattern, spacing is thus predetermined at a given boom height.

An option being used by some applicators to give more uniform coverage is the double overlap placement of nozzles. Twice the normal number of nozzles is used so that two nozzles spray any given area. This technique is especially useful in furrowed fields or when the terrain is rough. The double overlap system means that twice as much water is applied unless pressure, nozzle size, or travel speed is changed. Other techniques to improve uniformity are to spray twice at right angles, or to "lap half", i.e., drive so the center of the sprayer on each swath is at the end of the previous swath, so that the field is sprayed twice.

## **OPERATING PRECAUTIONS**

1. Never use a pin, knife, or other metal object to unplug a nozzle; use compressed air, a discarded toothbrush, or brush with soft bristles. Never blow into a nozzle to clean it because you may blow spray mixture back into your face.
2. Never allow dirty water or debris to enter the tank.
3. Control spray drift by:
  - (a) using the largest nozzle and the lowest pressure that will apply the herbicide properly.
  - (b) keeping the boom as low as permissible.
  - (c) never spraying on a windy or even a breezy day.
4. Do not use a herbicide sprayer to apply a fungicide or an insecticide on any crop.
5. Do not use corrosive fertilizer solutions in an ordinary weed sprayer.
6. Never operate a sprayer with any of the screens or filters removed. If the screen constantly becomes plugged, replace it with a screen with the proper mesh and capacity, or check for causes of the plugging.
7. Never fasten a PTO-driven pump solidly to the tractor with a bar. Most sprayer pumps should be kept from rotating with the chain provided. Fastening the pump with a bar usually causes rapid pump bearing wear.
8. Never allow any sprayer pump to run without water, even for a short time. Without water, pump seals, bearings, and other working parts may be severely damaged.
9. Never leave any herbicide in a tank, even during noon hour. Wettable powders settle rapidly and are difficult to resuspend.
10. Always pump a least 50 gallons of clean water through the sprayer at the end of the day or when changing from one herbicide to another. Clean the nozzle tips and all screens at the same time. This will help to reduce the gummy deposits, or the wettable powder accumulations, in the sprayer. Leaving the tank full of clean water will help reduce flaking inside an unlined steel tank.
11. Air blast or mist sprayers are designed to apply insecticides and/or fungicides. They should never be used to apply herbicides, especially hormone-type herbicides such as 2,4-D. The danger of causing herbicidal damage a long distance from the treated area is very great.



## CLEANING THE SPRAYER

There is no satisfactory way to completely remove all traces of any herbicide from a sprayer. Traces of chemicals in solution (2,4-D, etc.) cannot be completely removed from porous tanks (wooden, unlined steel tanks, etc.), hoses, pressure regulators, selector valves, and screens. If a herbicide sprayer must be used to apply an insecticide or fungicide, do not apply the insecticide or fungicide to a crop that may be damaged by the herbicide. Chemicals in suspension may not be as difficult to remove from the sprayer, but traces may still be present unless all parts are thoroughly cleaned.

**End-of-the-day cleaning.** Whenever wind or weather conditions force you to temporarily stop spraying, clean the sprayer to prevent gum or powder deposits in the pressure regulator, selector valve, nozzle tips, and on screens. Follow these simple steps:

1. Rinse the inside and outside of the tank with plenty of clean water.
2. Half fill the tank with clean water and spray it out at low pressure. While the sprayer is operating, (a) adjust the pressure regulator and the selector valve and, (b) remove the plugs in the ends of the three boom sections. A small amount of liquid detergent added to the clean water will help clean the inside of the sprayer system.
3. Clean the nozzles, nozzle screens, and suction screens with compressed air or a soft brush. Replace the screens and nozzles.
4. Leave the tank full of clean water if freezing weather is not expected.

**NEVER clean a sprayer near susceptible plants or where the wash water could contaminate farm ponds, streams, or other supplies of water.**

## STORING A SPRAYER

When a sprayer is properly prepared for storage and kept under cover instead of being parked in a distant fence corner to sit out over winter, years are added to its useful life, an obvious economic advantage to the owner. There is a recommended storage procedure:

1. Clean the sprayer thoroughly.
2. Lubricate all moving parts completely according to the manufacturer's recommendations.
3. Make a list of all faulty parts and order the new ones NOW--not next spring when it's time to start spraying.
4. Fill the tank with water and add the recommended quantity and type of rust inhibitor or new light oil (see instruction manual). Drain the tank. Leave all tank openings uncovered for better tank ventilation, but screen them to keep out dust and debris.
5. Clean all nozzle tips and screens with compressed air or a soft brush and kerosene. Store the tips and screens in a jar of new light oil or kerosene.
6. Remove, clean, and drain the pump. Fill it with the light oil or rust inhibitor recommended by the pump

manufacturer. Seal all pump openings to keep out dust and dirt.

7. Store in a covered or protected location.
8. Take the weight off any tires.
9. Cover with a tarp.

## **SOME COMMON SPRAYER TROUBLES**

### **Loss of pressure**

**Cause** -- Pressure regulator improperly adjusted or stuck open.

**Remedy** -- Adjust pressure regulator

\*\*\*\*\*

**Cause** -- Suction screen plugged.

**Remedy** -- Clean screen thoroughly.

\*\*\*\*\*

**Cause** -- Cracked or porous suction hose.

**Remedy** -- Replace hose.

\*\*\*\*\*

**Cause** -- Worn pump.

**Remedy** -- Replace or recondition pump according to the manufacturer's instructions.

\*\*\*\*\*

**Cause** -- Worn nozzle tips or orifices.

**Remedy** -- Replace nozzle tips or orifices.

\*\*\*\*\*

**Cause** -- Faulty gauge.

**Remedy** -- Replace gauge.

### **Excessive pressure**

**Cause** -- Pressure regulator improperly adjusted or stuck closed.

**Remedy** -- Readjust or replace.

\*\*\*\*\*

**Cause** -- By-pass hose plugged or too small.

**Remedy** -- Unplug the hose or replace it with a larger one.

\*\*\*\*\*

**Cause** -- Faulty gauge.

**Remedy** -- Replace gauge.

### **Pressure gauge needle jumps excessively**

**Cause** -- Gauge too sensitive.

**Remedy** -- Replace gauge or mount a flow restrictor between the gauge and the pump.

\*\*\*\*\*

**Cause** -- Air cushion for the surges in liquid flow is gone (surge tank is waterlogged).

**Remedy** -- Admit air into the pump's air chamber on the pressure side of the pump.

### **Nozzle plugging too frequently**

**Cause** -- Too coarse a nozzle screen.

**Remedy** -- Replace with the proper mesh screen.

\*\*\*\*\*

**Cause** -- Dirty water, chemical, or tank.

**Remedy** -- Drain tank and clean thoroughly; check suction screen for holes.

\*\*\*\*\*

**Cause** -- Nozzles too small.

**Remedy** -- Replace with the proper nozzles for the chemical being used.

\*\*\*\*\*

**Cause** -- Boom plugged.

**Remedy** -- Remove the plugs in the ends of the boom section to clean the boom.

satisfactory metering device consists of a fluted roller driven from a land wheel so that its revolutions are directly geared to the distance covered. Granules falling into the flutes are carried around and dropped into the distribution tubes. For the treatment of large areas, the most promising approach is the development of centrifugal distributors similar to those used for fertilizer spreading, but with more careful control of quantities and distribution. Granules can be distributed both from the air and from ground equipment by such a mechanism.

## **APPLICATION OF GRANULAR FORMULATIONS**

Granular formulations of herbicides have been used primarily in industrial areas and in certain row crops. Much of the corn and soybean acreage is treated with granular herbicides because application requires simply adding another hopper to the planter.

Several forms of application equipment are available. Machine design is limited by the fact that even distribution of granules of mixed size and density is difficult to obtain. Therefore, manufacture of uniform granules is important. Essentially the mechanism, whatever the scale, consists of a hopper, metering device, and distribution system. The smallest equipment for spot treatment of individual weeds may consist of a hand-held container fitted with a device allowing a small volume of granules to escape down a rigid tube. Application in bands is a technique often associated with weed control in row crops. The application equipment can be used, either on its own or in association with one or more planters, to lay down bands of granules during the planting operation. A

## STUDY QUESTIONS FOR CHAPTER 7

1. What are the advantages and disadvantages of an ordinary steel spray tank?
2. What are some materials used to fabricate spray tanks?
3. What are the agitation recommendations for soluble materials? For wettable powders (same for flowables and dry flowables)? For emulsions?
4. When should you use a 50-mesh suction strainer? A 100-mesh strainer.
5. What does 50-mesh mean?
6. List four types of positive displacement pumps and some advantages and disadvantages of each.
7. Name a non-positive displacement pump and some advantages and disadvantages.
8. What is meant by "drop nozzles"? For what purpose are they used?
9. What is "band" spraying? When is it used? What type of nozzle is used?
10. Name some materials used to make nozzle tips. Which are cheapest? Which are most corrosion and abrasion resistant?
11. Assuming fixed nozzle spacing, do you raise or lower the boom when switching from 73<sup>o</sup> tips to 80<sup>o</sup> ones?
12. What is the difference in pattern between a regular flat fan and an even-spray flat fan?
13. What are some ways to improve uniformity of a spray application to a field?
14. How do you eliminate nozzle "dribble"?
15. How do you adjust the angle of flat fan nozzles in relation to the boom? Why?
16. Will increasing nozzle orifice size increase or decrease drift?
17. How do you clean a clogged nozzle?
18. How do you clean the sprayer after use?



## CHAPTER 8 CALIBRATION

Calibration means determining the output of a sprayer or spreader for a given area so that the desired rate of a herbicide can be applied. Calibration of herbicide application equipment should be done with new equipment and periodically with all equipment after it has been put in service. There are several ways to accurately calibrate pesticide application equipment. This will describe one method that is simple and that can be adapted to the calibration of various types of equipment. In essence, it relates (a) the measured output over a measured area to (b) the calculated output over a standard unit of area, such as an acre.

There are dozens of special formulas for making the appropriate calculations in calibrating. Most of these are relatively easy to use and are quite satisfactory. If you have one of these formulas, it may be the preferred method for you. However, most people cannot remember the formula from one calibration to the next and must depend on having the notebook on hand when calibrating. The method presented here requires the calibrator to remember only two items: (a) There are 43,560 square feet per acre. This is a familiar number to most agriculturists. (b) How to do a ratio problem. That is about sixth-grade arithmetic and should not present a problem.

The first step of this method is to measure the output of the application over a given area. Any type or size of equipment sprayer or granular spreader, 3-foot hand spreader or 60-foot spray boom, may be used. The given area can be any size.

There are some things that should be done before beginning the actual calibration process. All equipment should be checked for proper function and adjusted as suggested by the manufacturer or to the user's own specifications. For sprayers, this may entail replacing worn nozzle tips, making sure the pump is providing adequate capacity (pressure and volume), and tightening loose connections or otherwise correcting leaks. Nozzle tips made from soft materials, such as aluminum or brass, wear rapidly when spraying abrasive suspensions of wettable powder formulations. This wear may not be readily observable and although recalibration can compensate for the increased flow rate, excessive wear may result in undesirable changes in the spray distribution pattern.

Spray pattern is one of the most critical factors in obtaining effective pesticide application. Boom sprayers should be adjusted to provide the recommended overlap of the nozzles. Single nozzle equipment should be adjusted to give the desired swath width. One of the simplest and most accurate ways of determining correct boom height is by spraying on dry pavement or dry soil and observing the pattern as the spray dries. Skips and overlaps quickly become apparent. Pre-calibration checks for granule application equipment are similar to those for sprayers, with checks for wear and adjustment.

With granular applicators, the easiest way to measure output probably is to fasten a container beneath the spreader,

collect the granules, and weigh them. One can always weigh the entire rig before and after application to a given area, but this is less accurate.

For sprayers, the easiest method is to drive for any measured distance at the speed at which the sprayer will be operated. Measure the time it took to drive that distance. Park the sprayer, turn it on, collect the spray from one or more nozzles (more is better), and thus measure the spray output for the same length of time. Multiply the output from one nozzle times the number of nozzles on the boom.

Remember that the width of the spray pattern is equal, not to the length of the boom, but the spacing between nozzles times the number of nozzles (not the number of spaces). This is because there is spray applied outside the two outside nozzles.

Now you have all the information you need. The next step is to set up a simple ratio; number of gallons per number of square feet is to X gallons per 1 A (or 43,560 sq ft).

$$\frac{\text{gallons measured}}{\text{sq ft measured}} = \frac{X \text{ (gallons)}}{43,560 \text{ sq ft}}$$

To solve, cross multiply.

$$\begin{aligned} (\text{gal measured}) \text{ times } (43,560) &= (X) \\ \text{times (sq ft measured)} & \end{aligned}$$

$$X = \frac{(\text{gal meas.})(43,560)}{\text{sq ft measured}}$$

To illustrate, here is a simple example:

$$\begin{aligned} \frac{2}{4} &= \frac{X}{24} & 4X &= 48 \\ & & X &= 12 \end{aligned}$$

In other words, 12 and 24 are in the same ratio as 2 and 4.

The following is an example of the calculations used in calibrating a sprayer:

The effective spray swath is 3 feet and the measured volume sprayed in 500 feet of travel is 11 pints (1.375 gallons), these values can be used as follows:

$$\frac{1,375 \text{ gal}}{3 \times 500} = \frac{X}{43,560}$$

$$\begin{aligned} 1500 X &= (1.375)(43,560) \\ X &= 39.93 \text{ gal per acre} \end{aligned}$$

Rounding this value, the sprayer is calibrated to deliver 40 gallons of spray per acre.

Additional information and calculations are needed. Continuing with the above example, assume the sprayer has a 200 gallon tank and that a wettable powder formulation herbicide is to be sprayed at a recommended rate of 8 pounds of formulated product per acre. Using this information, the necessary calculations would be:

$$\frac{200 \text{ gal tank}}{40 \text{ gal per acre}} = 5 \text{ acres per tank}$$

$$\begin{aligned} (5 \text{ acres per tank}) \times (8 \text{ pounds} \\ \text{per acre}) &= 40 \text{ pounds per tank} \end{aligned}$$

Therefore, the person mixing the spray would add 40 pounds of the herbicide product to make up a full tank of spray and would expect the tank to cover 5 acres of sprayed area.

From this example, it is apparent that sprayer calibration is a simple process. Good management practices dictate that pesticide application equipment be calibrated relatively frequently. Calibration checks also should be made by continually calculating equipment output as herbicide applications are made.

To this point, consideration has been given only to calibration with water and for most sprays this will provide adequate accuracy. Very "light" petroleum distillates used without mixing with water, and thickened sprays, as may result with the use of certain adjuvants, may have viscosities sufficiently different from water to cause calibration with water to be inaccurate.

Generally, this inaccuracy is slight and should not lead to problems. If you suspect the spray solution is delivered at a significantly different rate than water, you can always mix up a spray solution and collect the spray solution from all the nozzles (to avoid spraying it on the ground) for the same length of time as it took to drive the measured distance. The new figures can be used for calculations and the collected spray solution can be returned to the spray tank. For a large sprayer, that may take many containers, but the increased accuracy may be worth the effort.

### **Examples of Other Methods**

#### **Method #1**

1. Set stakes at some convenient distance, i.e., 200 ft or 500 ft, etc.
2. Start with a full tank; set pressure and speed as will actually be used in field.

3. Spray the measured length, measure amount needed to refill tank, and calculate gallons per acre (gpa).

#### 4. Calculation

$$\text{gpa} = \frac{43,560 \times \text{gallons used}}{\text{length of trial strip} \times \text{spray width}}$$

Example: Spray width = 20 ft wide; 10 gallons used in driving 500 ft

$$\text{gpa} = \frac{43,560 \times 10}{500 \times 20} = 43.6$$

5. If, in the above example, 43.6 gpa is a suitable application volume, add the correct amount of herbicide and spray. If not, change nozzle orifice or ground speed and recalibrate.

**NOTE: All measurements should be on a level area.** This measurement is usually less accurate because of the difficulty of measuring the amount used from a large tank.

#### **Method #2**

1. Put some water in the sprayer, set the pressure, and operate the sprayer in place. Catch the discharge from about 1/3 of the nozzles (assuming the output of each nozzle is the same as all others on the boom) for 1 minute in containers.
2. Then, with rig at field speed and pressure, drive for 1 minute.
3. Determine the distance traveled.
4. Compute the GPA.
5. Computations:



Example: Average delivery of 1 nozzle = 1 qt/min. Total boom delivery in 1 min = 1 qt X number of nozzles.

Assuming 12 nozzles: 12 X 1 qt = 12 qts = 3 gal/min

If spray width = 20 ft, and the sprayer travels 300 ft in one min:

$$\frac{3 \text{ gal}}{20 \times 300} = \frac{X \text{ gal}}{43,560 \text{ sq ft}}$$

$$6,000 X = (43,560) X (3)$$

$$X = 21.8 \text{ gpa (or 22 gallons)}$$

6. If the 22 gallons per acre is adequate, add the correct amount of herbicide for each 22 gallons of field mixture and proceed to spray. If not, change nozzles or speed and recalibrate.

To make minor adjustments in output to achieve the desired rate, the sprayer speed can be changed. To double the output, speed needs to be reduced by half. To make that large a change in output, changing nozzle tip size is generally preferable. Only very minor adjustments should be made by adjusting pressure, because pressure must be quadrupled to double the output. For minor changes, changing speed is generally preferable to changing pressure.

## STUDY QUESTIONS FOR CHAPTER 8

1. What does calibration mean?
2. List three items on the apparatus that should be checked before starting to calibrate.
3. What is a cheap and simple way to assure that the boom height (and therefore overlap) is correct?
4. To reduce the output of a sprayer by half, how would you adjust the speed and by how much.
5. To double the output, how much do you need to increase pressure?
6. What is the best way to make major changes in output? minor changes?
10. How many pounds active ingredient should be included in each tankful?
11. How many pounds of the wettable powder should be included in each tankful?
12. How many gallons of the EC should be added to each tankful?

Assume: John Deere sprayer with a piston pump operated at 30 psi. 20 nozzles on a boom, spaced at 1.5 feet. Time required to drive 300 feet is .68 min. Each nozzle delivers 0.31 gallons in .68 min. Tank holds 300 gallons. Field size is 1,000 feet long and 523 feet wide.

7. How many acres are in the field?
8. How many gallons per acre is the system applying?
9. How many acres will one tankful spray?

Assume in the above situation, you wish to apply 3 pounds active ingredient formulated either as (a) an 80% wettable powder or (b) a 4 lb/gal emulsifiable concentrate.



## CHAPTER 9 THE LABEL

The herbicide label is extremely important to every user. The information and instructions on it come from years of costly tests and studies. The label tells you how to safely and correctly use the herbicide. The label, when properly followed, provides protection for applicators, consumers, and the environment. Completely read all labels for every herbicide you use. **Don't rely on your memory.**

### IDENTIFICATION OF CHEMICAL HAZARDS

First, the label identifies the chemicals in the container. The contents are listed in a standard form so that you know exactly what you are applying. Mistaken uses of chemicals can cause crop injury, poor control, or illegal residues. The crop may be unfit for market, making you, the applicator, legally responsible for any losses.

Signal words are used on labels to indicate the level of acute toxicity of the herbicide to humans. The label also lists the protective equipment needed for proper handling and use of the chemical. This may include masks, gloves, respirators, etc. The applicator who often works with these chemicals must be especially careful. Don't take chances with your health--follow the safety requirements on the label.

### REGISTERED USES

The label lists the uses for the herbicide

that are approved by the Environmental Protection Agency (EPA). If the intended use is not on the label, the product should not be used! You are legally responsible for any accident or crop loss resulting from using materials that are not approved. Certain formulations of a particular herbicide may be intended only for a specific use. For example, herbicide A may be labeled only for weed control in beans. While there may be other herbicides made of the same active ingredient labeled for use in other crops, the use of Herbicide A on a crop other than beans would be a misuse, and may subject the applicator to enforcement action by the licensing agency, lawsuit, or both.

### RECOMMENDED DOSES

Recommended doses and directions for use also appear on every label. These suggestions can be helpful to you because they state the maximum dosage permitted by law. However, local conditions may not require maximum doses to achieve effective control of the plant. You should use no more herbicide than is needed.

### COMPATIBILITY

The label will usually state which other chemicals can be mixed with the herbicide. Often, other herbicides or fertilizers can be combined with the herbicide for one application. Sometimes the chemicals cannot be mixed without destroying their effectiveness. Check on compatibility **before** you mix.

## THE LABEL AND THE LAW

The label is the law. Herbicide users are forbidden to use a herbicide in a way contrary to its labeling. Any use not indicated on the label is prohibited. It is also illegal for consultants or sales persons to recommend a herbicide be used contrary to its label. The information found on the label has passed strict government requirements. The label itself, not just the herbicide product, must be registered by the EPA before it is used. EPA reviews and approves each statement that is on the label. The EPA Label Improvement Program updates herbicide labels in areas that contribute to health and environmental safety. According to the program, herbicide manufacturers revise product labels so both the applicator and the regulatory agency can delineate legal and safe uses for herbicides released after April 30, 1988. As part of health and safety, the toxicity warnings on labels come from tests required by the government. The herbicide and the label are registered by EPA only when handlers, loaders, consumers, and environment in general will be protected. If the label directions are carefully followed, no illegal residues will be found on any crop. Applicators, dealers, consultants, and salesmen making recommendations other than those recommended on herbicide labels are liable under the law. However, the state university may advise using lower rates than specified on the label. This is not illegal.

Getting a single herbicide ready for registration can take seven to nine years and usually costs the chemical company \$20-40 million dollars. Surely if it costs that much, the label is worth reading!

Each herbicide you buy has a label giving you instructions on how to use the

product. Labels vary greatly depending on what the product is used for, when it was issued or reviewed, size of the package, and company format.

## LABEL

The label is the information printed on or attached to the container of a herbicide.

- To the manufacturer, the label is a "license to sell."
- To the state or federal government, the label is a way to control the distribution, storage, sale, use, and disposal of the product.
- To the buyer or user, the label is a source of facts on how to use the product correctly and legally.
- To physicians, the label is a source of identification and information on proper treatment for poisoning cases.

All labels will tell you how to use the product correctly!

## PARTS OF THE LABEL

**Brand, Trade, or Product Names.** Each manufacturer has a brand name for their product. Different manufacturers may use different brand names for the same active ingredient. The brand name shows up plainly on the front panel of the label. Applicators should avoid choosing a herbicide product by brand name alone. Companies may change the active ingredients in their product to something entirely different. Roundup in the 1960's was propachlor + 2,4-D. Roundup now is

glyphosate. Their uses and characteristics are entirely different.

**Classification.** Every use of every herbicide will be classified by the U.S. Environmental Protection Agency as either "general" or restricted." Every restricted herbicide product must carry this statement in a prominent place at the top of the front panel of the herbicide label:

**"RESTRICTED USE PESTICIDE. For retail sale and use only by certified applicators or persons under their direct supervision and only for those uses covered by the certified applicator's certification."** The absence of a **RESTRICTED USE** statement does not necessarily indicate that the product has a low hazard level. Use the signal word and the precautionary statements to judge the toxicity hazard of all herbicide products.

**Ingredient Statement.** Each herbicide label must list what is in the product. The list is written so that you can see quickly what the active ingredients are and the amount (in percentage) of each ingredient listed. The ingredient statement must list the official chemical names and/or common names for the active ingredients. Inert ingredients need not be named, but the label must show what percentage of the total contents they comprise. Generally, the pounds of acid equivalent per gallon are noted for acid-based herbicides.

**Chemical Name.** The chemical name is a complex name which identifies the chemical components and structure of the herbicide. This name is almost always listed in the ingredient statement on the label. For example, the chemical name of the active ingredient in Aatrex 80W, atrazine, is 2-chloro-4-ethylamino-6-isopropylamino-s-triazine.

**Common Name.** Because herbicides have complex chemical names, many are given a shorter "common" name. Only common names which are officially accepted by the U.S. Environmental Protection Agency may be used in the ingredient statement on the label. The official common name may be followed by the chemical name in the list of active ingredients. A label with the trade name Buctril would read:

Active ingredient:

Octanoic ester of bromoxynil (3,5-dibromo-4-hydroxybenzotrile).....33.4%  
Inert ingredients .....66.6%

Bromoxynil octanoate equivalent to 22.9% of bromoxynil or not less than 2.0 pounds bromoxynil per gallon.

**Type of Herbicide.** The type of herbicide usually is listed on the front panel of the herbicide label. This short statement usually indicates the kind of plants that the product will control.

Examples:

- Herbicide for control of certain weeds in rice, small grains, and peas.
- A weed, grass, and harvest herbicide.
- Herbicide for the control of trees, brush, and weeds.

**Net Contents.** The front panel of the herbicide label will tell you how much is in the container.

**Name and Address.** The law requires one of the following names and addresses to be included on every EPA-registered label:

1. Manufacturer or producer.
2. Registrant.
3. Person or company for whom the pesticide was produced.

One of the above must appear on the product label.

**Registration and Establishment Numbers.** These numbers are needed by the herbicide applicator in case of accidental poisoning, claims of misuse, faulty product, or liability claims.

**Registration Numbers.** An EPA registration number appears on all herbicide labels, unless an older label has a USDA number. This indicates the herbicide label has been registered by the federal government. Most products will contain only two sets of numbers, for example, EPA Reg. No. 3120-280; the first set of digits, 3120, is the manufacturer's identification number and the second set, 280, is the product identification number. Sometimes additional letters and numbers are part of the EPA Registration Number, for example 3120-280-AA-0850. The letters AA are alpha (alphabetical) letters required by a particular state and will appear on a few labels. The 0850 is the distributor's identification number and will appear on some labels.

In some cases, *special local need* (SLN) registrations may be approved by a state. These registrations are designated, for example, as EPA, SLN No. OR-770009. In this case, SLN indicates "Special local need" and OR indicates that the product is registered for use in Oregon. SLN numbers may not necessarily appear on the package label, but are part of the SLN label, which is available as supplemental labeling. Use of a herbicide covered by SLN labeling requires that the users have the SLN label in

their possession at the time of use.

**Establishment Numbers.** The establishment number (for example, EPA Est. No. 5840-AZ-1) appears on either the label or the container. In case something goes wrong, it identifies the facility that produced, repackaged, or re-labeled the product.

**Signal Words and Symbols.** Almost every label contains a signal word that will give you a clue to how dangerous the product is to humans. Knowing the product's hazard helps you to choose the proper precautionary measures for yourself, your workers, and other people (or animals) who may be exposed.

The signal word must appear in large letters on the front panel of the herbicide label. It usually is next to the statement, "Keep Out of Reach of Children", which must appear on every herbicide label.

**DANGER** -- (Oral LD<sub>50</sub> = 1-50 mg/kg) Any product that is highly toxic orally, dermally, through inhalation, or causes irreversible eye injury or severe skin burning will be labeled **DANGER**. In addition, all herbicides that are highly toxic orally, dermally, or through inhalation will carry the word **POISON** printed in red and the skull and crossbones symbol. As little as a taste to as much as a teaspoonful taken by mouth could kill an average sized adult.

If a herbicide receives a highly toxic rating because of the possibility for corrosive damage to the skin or eyes, the signal word **DANGER** will be on the label without the word **POISON**.

**WARNING** -- (Oral LD<sub>50</sub> = 50-500 mg/kg) Any product that is moderately

toxic orally, dermally, or through inhalation or causes moderate eye and skin irritation, will be labeled **WARNING**. A teaspoonful to a tablespoonful orally could kill the average sized adult.

**CAUTION** -- (Oral LD<sub>50</sub> = 500-5000 mg/kg) Any product which is slightly toxic to relatively non-toxic orally, dermally, or through inhalation or causes slight eye and skin irritation, will be labeled **CAUTION**. An ounce to more than a pint taken orally could kill the average adult.

**Precautionary Statements.** All herbicide labels contain additional statements to help you decide the proper precautions to take to protect yourself, your helpers, and other persons (or domestic animals) that may be exposed. Part or all of the herbicide label may be written in other languages; the same label requirements apply regardless of the language.

**Route of Entry Statements.** The statements which immediately follow the signal word, either on the front or side of the herbicide label, indicate which route(s) of entry (mouth, skin, lungs) you must particularly protect. Many herbicide products are hazardous by more than one route of entry, so study these statements carefully. A "**Danger**" signal word followed by "*may be fatal if swallowed or inhaled*" gives you a far different warning than, "*Danger: Corrosive -- causes eye damage and severe burns.*"

Typical **DANGER** label statements include:

- Fatal if swallowed.
- Poisonous if inhaled.
- Extremely hazardous by skin contact -- rapidly absorbed through skin.

- Corrosive -- causes eye damage and severe skin burns.

These statements are not uniform on all labels and many variations may be found. More than one or, in some cases, all four precautions may be stated on the same label.

Typical **WARNING** label statements include:

- Harmful or fatal if swallowed.
- Harmful or fatal if absorbed through the skin.
- Causes skin and eye irritation.

Statements on a **WARNING** label may be exactly like those found on a **DANGER** label or a **CAUTION** label. There may be a combination of the two, for example "*harmful or fatal.*"

Typical **CAUTION** label statements include:

- Harmful if swallowed.
- May be harmful if absorbed through the skin.
- May be harmful if inhaled.
- May irritate eyes, nose, throat, and skin.

These statements may vary considerably. They usually are more moderate than the statements found on a **DANGER** label, often using "*harmful*" instead of "*fatal*" or "*poisonous*"; "*irritant*" instead of "*corrosive*"; and qualifying the warnings



with "*may*" or "*may be*." This is in keeping with products having a **CAUTION** label.

**Specific Action Statements.** These statements usually follow the route of entry statements. They recommend the specific action needed to prevent poisoning accidents. These statements are directly related to the toxicity of the herbicide product (signal word) and route(s) of entry which must be protected.

**DANGER** labels typically contain statements such as:

- Do not breathe vapors or spray mist.
- Do not get on skin or clothing.
- Do not get in eyes.

(You would not deliberately swallow the herbicide, so the "Do not swallow" statement is omitted.)

**CAUTION** labels generally contain specific action statements which are much milder than those on the **DANGER** label:

- Avoid contact with skin or clothing.
- Avoid breathing dusts, vapors, or spray mists.
- Avoid getting in eyes.

These statements indicate that the toxicity hazard is not as great. The specific action statements help you prevent herbicide poisoning by taking the necessary precautions and wearing the correct protective clothing and equipment.

**Hazards to Wildlife.** The label may indicate that the product causes undesirable effects in the environment. In this case, the

precautionary statement may tell you what to avoid doing. Some labels indicate toxicity to bees, birds, fish, and crustaceans. Labeling may indicate limitations imposed to protect endangered species. These limitations may include reduced rates, restrictions on types of application, or a ban on the herbicide's use within the species range. The label may also tell you where additional information can be obtained.

**Protective Clothing and Equipment Statements.** Herbicide labels vary in the type of protective equipment statement they contain. Some labels fully describe appropriate protective equipment. A few list the kinds of respirators that should be worn when handling and applying the product. Others require the use of a respirator but do not specify type of model to be used. Many labels carry no statement at all.

You should follow all advice on protective clothing or equipment appearing on the label. However, the lack of any statement or the mention of only one piece of equipment does not rule out the need for additional protection.

The best way to determine the correct type of protective equipment is to use the signal word, the route of entry statements, the formulation, and the specific action statements. Sensible selection of protective equipment depends on a thorough understanding of the herbicide, the job, the weather, the handler, and how these factors interact.

A **WARNING** label, for example, might carry the statements: "Causes skin and eye irritation. Do not get in eyes, on skin, or on clothing. Wear goggles while handling." Even though the label does not

specifically require them, you should wear coveralls over regular work clothing, chemical-resistant gloves, and footwear. You should wear a chemical-resistant protective suit and hat if you will be in prolonged contact with the chemical or are using an overhead spray application.

The safe use of herbicides depends on risk awareness, use of appropriate protective equipment, skill at handling equipment and herbicides, careful personal hygiene, and regular medical care.

**Other Precautionary Statements.** Labels often list other precautions to take while handling the product.

- Do not contaminate food or feed.
- Remove and wash contaminated clothing before reuse.
- Wash thoroughly after handling and before eating or smoking.
- Wash clothes daily.
- Not for use or storage in and around the house.
- Do not allow children or domestic animals into the treated area.

These statements represent actions which an applicator should always follow whether they are on the label or not.

**First Aid or Statement of Practical Treatment.** These statements tell you the first aid treatments recommended in case of poisoning. Typical statements include:

- In case of contact with skin, wash immediately with plenty of soap and water.

- In case of contact with eyes, flush with water for 15 minutes and get medical attention.
- In case of inhalation exposure, move from contaminated area and give artificial respiration if necessary.
- If swallowed, drink large quantities of milk, egg white, or water -- do not induce vomiting.

All **DANGER** labels and some **WARNING** and **CAUTION** labels have a section on First Aid Treatment, Poison Signs or Symptoms, Note to Physicians, or Antidote and an Emergency Assistance Call telephone number. **WARNING** and **CAUTION** labels usually do not provide this information, although some may provide an Emergency Assistance Call telephone number near the signal word or precautionary statements. Individuals experiencing poisoning symptoms should seek medical attention. The herbicide label is an extremely important document that should accompany the victim to the treatment facility.

**Environmental Hazards.** Herbicides may be harmful to the environment. Some products are classified **RESTRICTED USE** because of environmental hazards alone. Label warnings may include groundwater advisories and protection information. Look for special warning statements on the label concerning hazards to the environment.

**Special Toxicity Statements.** If a particular herbicide is especially hazardous to wildlife, it will be stated on the label. For example:

- This product is highly toxic to bees.

- This product is toxic to fish.
- This product is toxic to birds and other wildlife.

These statements alert you to the special hazards that the use of the product may pose. They should help you choose the safest product for a particular job and remind you to take extra precautions.

**General Environmental Statements.**

These statements appear on nearly every herbicide label. They are reminders of common sense actions to follow to avoid contaminating the environment. The absence of any or all of these statements **DOES NOT** indicate that you do not have to take adequate precautions.

Sometimes these statements will follow a "specific toxicity statement" and provide practical steps to avoid harm to wildlife.

Examples of general environmental statements include:

- Do not apply when runoff is likely to occur.
- Do not apply when weather conditions favor drift from treated areas.
- Do not contaminate water when cleaning equipment or disposing of wastes.
- Keep out of any body of water.
- Do not allow drift on desirable plants or trees.
- Do not apply when bees are likely to be in the area.

- Do not apply where the water table is close to the surface.

**Physical or Chemical Hazards.** This section of the label will tell you of any special fire, explosion, or chemical hazards the product may pose. For example:

- Flammable -- Do not use, pour, spill, or store near heat or an open flame. Do not cut or weld container.
- Corrosive -- Store only in a corrosion-resistant tank.

**NOTE:** Hazard statements (hazards to humans and domestic animals, environmental hazards, and physical-chemical hazards) are not located in the same place on all herbicide labels. Some newer labels group them in a box under the headings listed above. Other labels may list them on the front panel beneath the signal word. Still, other labels list the hazards in paragraph form somewhere else on the label, under headings such as "Note" or "Important." You should search the label for statements which will help you to apply the herbicide safely and knowledgeably.

**Reentry Statement.** Some herbicide labels contain a reentry precaution. This statement tells you how much time must pass before people can reenter a treated area without appropriate protective clothing. These reentry intervals are set by both EPA and some states. Reentry intervals set by states are not always listed on the label. It is your responsibility to determine if one has been set. It is illegal to ignore reentry intervals.

The minimum standard for legal protective clothing for early reentry

following agricultural and other outdoor treatments are:

- A long-sleeved shirt
- Long-legged trousers or coveralls.
- Hat.
- Sturdy shoes with socks.
- Gloves are suggested.
- A respirator may be necessary for early re-entry in enclosed areas.
- Do not contaminate water, food, or feed by storage and disposal.
- Open dumping is prohibited.
- Triple-rinse and offer this container for recycling or reconditioning, or dispose in an approved landfill or bury in a safe place.
- Use excess or dispose in an approved landfill or bury in a safe place.
- Do not reuse bag. Burn or bury in a safe place.

The reentry statement may be printed in any one of several places, such as under "General Information," or "Directions for Use," etc. If no reentry statement appears on the label and is not set by your state, then you must wait at least until sprays are dried or dusts have settled before reentering, or allowing others to reenter a treated area without protective clothing. This is the minimum legal reentry interval.

**Storage and Disposal.** All herbicide labels contain general instructions for the appropriate storage and disposal of the herbicide and its container. State and local laws vary considerably, so specific instructions usually are not included. Typical statements include:

- Not for use or storage in or around the home.
- Store away from fertilizers, insecticides, fungicides, and seeds.
- Store at temperatures above 32<sup>o</sup>F (0<sup>o</sup>C).
- Do not reuse container.

You should try to determine the best storage and disposal procedures for your operation and location. These statements may appear in a special section of the label titled "Storage and Disposal" or under headings such as "Important," "Note," or "General Instructions." For additional information on proper herbicide disposal and storage, contact your state regulatory agency.

**Directions for Use.** Correct application of a herbicide product is accomplished by following the use instructions found on the label. The use instructions will tell you:

- The plants that the manufacturer claims the product will control. (Federal law legally allows you to apply a herbicide against a plant that is not specified on the labeling if the application is to a crop, animal, or site which the labeling approves.
- The crop, animal, or site the product is intended to protect.
- In what form the product should be applied.

- The proper equipment to be used.
- How much to use.
- Mixing directions.
- Compatibility with other often-used products.
- Phytotoxicity and other possible injury.
- Where the material should be applied.
- When it should be applied.

Labels for agricultural herbicides often list the least number of days which must pass between the last herbicide application and crop harvest, slaughter, or grazing livestock. These are intervals set by EPA to allow time for the herbicide to break down in the environment. This prevents illegal residues on food, feed, or animal products, and possible poisoning of grazing animals. This information may appear as a chart or it may be listed just after the application directions for the target crop or animal.

## **DIRECTIONS FOR USE BY REFERENCE**

In the future there may be some directions for use (which herbicide applicators must obey) that are referred to on the label, but may not come with the product when it is sold. Directions by reference may include safe-use instructions required by EPA regulations. As an example, a herbicide label may have a statement like this:

**"You must use this product in a manner consistent with its labeling and with EPA Worker Protection**

## **Standards for Agricultural Herbicides, Part 170 of Title 40, Code of Federal Regulations."**

This statement means you are responsible for determining if the regulation applies to your situation and intended use of that herbicide. If the regulation does apply, you are responsible for complying with these directions as well as the label and labeling directions. EPA regulations that may require additional herbicide use directions are:

- agricultural worker protection.
- ground and surface water protection.
- endangered species protection.
- herbicide transportation, storage, and disposal.

The use directions for each of the programs above may be long and exceed the room available on the traditional herbicide label. EPA's decision to refer to use directions places great responsibility on the herbicide applicator. A paragraph or a sentence on the label may be the only notice an applicator will receive that more directions are required for proper and legal application of that product.

## **READING THE LABEL**

**Before you buy a herbicide, read the label to determine:**

- Whether it is the herbicide you need for the job.
- Whether the herbicide can be used safely under the application conditions.

- Where the herbicide can be used.
- Whether there are any restrictions for use of the herbicide.
- How much product you need.

**Before you mix the herbicide**, read the label to determine:

- What protective equipment you should use.
- What the pesticide can be mixed with (compatibility).
- How much herbicide to use.
- The mixing procedure.

**Before you apply the herbicide**, read the label to determine:

- What safety measures you should follow.
- When to apply the herbicide (including the waiting period for crops and animals).
- How to apply the herbicide

**Before you store or dispose of the herbicide or herbicide container**, read the label to determine:

- Where and how to store the herbicide.
- How to decontaminate and dispose of the herbicide container.
- Where and how to dispose of surplus herbicides.

PRODUCT NAME

# Mectrol MCPA SODIUM

TYPE OF PESTICIDE

INGREDIENT STATEMENT

Brand Name

CONTROLS WEEDS IN RICE, SMALL GRAINS, AND PEAS

ACID EQUIVAL.

ACTIVE INGREDIENT:  
 \*Sodium salt of 2-methyl-4-chlorophenoxyacetic acid ..... 24.0%  
 INERT INGREDIENT: ..... 76.0%  
 \*2-Methyl-4-chlorophenoxyacetic acid equivalent 21.7% or 2 pounds per gallon.

EPA Reg. No. 123-45AA

EPA Est. No. 123-LD-01

EPA REGISTR. NO.

**KEEP OUT OF REACH OF CHILDREN**  
**DANGER PELIGRO**

EPA ESTAB. NO.

PRECAUCION AL USUARIO: Si usted no lee ingles, no use este producto hasta que la etiqueta le haya sido explicada ampliamente.

CHILDREN STATEMENT

STATEMENT OF PRACTICAL TREATMENT

SPECIFIC ACT. STATE.

IF IN EYES: Flush with water for at least 15 minutes and get medical attention.

SIGNAL WORD

For PRODUCT USE Information Call 1-800-334-9745

For MEDICAL And TRANSPORTATION Emergencies ONLY Call 24 Hours A Day 1-800-334-7577

## PRECAUTIONARY STATEMENTS

PRECAUTION STATEMENTS

### DANGER

#### HAZARDS TO HUMANS AND DOMESTIC ANIMALS

Corrosive. Causes eye damage. Harmful if swallowed. May be fatal if absorbed through the skin. Do not get in eyes, on skin or on clothing. Avoid breathing spray mist. Wear goggles or face shield when handling concentrate. In case of contact immediately flush eyes or skin with plenty of water. Get medical attention if irritation persists. Remove and wash contaminated clothing before reuse.

#### STATEMENT OF PRACTICAL TREATMENT

IF SWALLOWED: If patient is conscious and alert, give 2 to 3 glasses of water to drink. Do not induce vomiting. Get medical attention.

IF ON SKIN: Immediately wash skin with plenty of soap and water, if available, while removing contaminated clothing and shoes. Shoes and clothing contaminated by substantial spillage of concentrated product should be discarded in a manner which limits further exposure. Otherwise, wash clothing separately before reuse. Get medical attention.

FIRST AID STATEMENTS

IF INHALED: Remove victim to fresh air. If not breathing, give artificial respiration. Administer oxygen if necessary. Get medical attention.

IF IN EYES: Hold eyelids open and flush with a steady, gentle stream of water for at least 15 minutes. Get medical attention, preferably an ophthalmologist.

#### NOTE TO PHYSICIAN

No specific antidote is available. All treatments should be based on observed signs and symptoms of distress in the patient. Overexposure to materials other than this product may have occurred.

This product is irritating to mucous membranes. If large amounts (greater than 1 ml/kg body weight) of the product have been ingested, the stomach should be evacuated by gastric intubation with the aid of a cuffed endotracheal tube to prevent exposure of the esophagus. After removal of stomach contents, wash stomach by instilling 30 to 50 g of activated charcoal in 3 to 4 ounces of water through the stomach tube and again remove stomach contents. Avoid oily laxatives.

#### ENVIRONMENTAL HAZARDS

Drift or run-off may adversely affect non-target plants. Do not apply directly to water except as specified on this label. Do not contaminate water when disposing of equipment washwater.

Avoid spray drift to susceptible plants such as cotton, beans, peas, and ornamentals as injury may result. Coarse sprays are less likely to drift. Do not apply MCPA sodium salt with nozzles that produce a fine spray.

ENRIVONM. HAZARDS

Groundwater Contamination: Most cases of groundwater contamination involving phenoxy herbicides such as MCPA have been associated with mixing/loading and disposal sites. Caution should be exercised when handling MCPA pesticides at such sites to prevent contamination of groundwater supplies. Use of closed systems for mixing and transferring this pesticide will reduce the probability of spills. Placement of the mixing/loading equipment on an impervious pad to contain spills will help prevent groundwater contamination.

Cleaning Equipment: Do not use same spray equipment for other purposes unless thoroughly cleaned. When cleaning equipment, do not pour washwater on the ground, spray or drain over a large area away from wells and other water sources. Do not use in a greenhouse.

## DIRECTIONS FOR USE

IT IS A VIOLATION OF FEDERAL LAW TO USE THIS PRODUCT IN A MANNER INCONSISTENT WITH ITS LABELING. Do not apply MECTROL brand MCPA Sodium Salt Herbicide through any type of irrigation system.

### GENERAL INFORMATION

MECTROL brand MCPA Sodium Salt Herbicide is effective on a wide range of broadleaf weeds and is useful for controlling these weeds in certain crops. Several crops, such as oats, rice, and small grains underseeded to legumes, are more tolerant of MCPA than of 2,4-D.

MECTROL Herbicide is the sodium salt of MCPA and is readily dissolved in water, even in the hard waters found in some areas. Mix thoroughly while diluting this material and mix again if allowed to stand for an extended period of time before spraying.

**COMPATIBILITY:** If MECTROL brand MCPA Sodium Salt Herbicide is to be tank mixed with other pesticides, compatibility should be tested prior to mixing. To test for compatibility, use a small container and mix a small amount (0.5 to 1 quart) of spray, combining all ingredients in the same ratio as the anticipated use. If any indications of physical incompatibility develop, do not use this mixture for spraying. Indications of incompatibility usually will appear within 5 to 15 minutes after mixing. Read and follow all directions and precautions on this label and on the labels of any product(s) for which a tank mixture is being considered.

To convert locally recommended application rates into amount of MECTROL Brand MCPA Sodium Salt Herbicide, use the following table:

#### Conversion of pound acid equivalent of MCPA to pints of MECTROL Brand MCPA Sodium Salt Herbicide

MCPA acid equivalent	1/4 lb.	3/8 lb.	1/2 lb.	3/4 lb.	1 lb.	1 1/4 lb.	1 1/2 lb.
MECTROL Herbicide	1 pt.	1 1/2 pts.	2 pts.	3 pts.	4 pts.	5 pts.	6 pts.

*Injury to crops may occur from this herbicide. If you are not prepared to accept some degree of crop injury, do not use this product.*

Crop varieties vary in response to MCPA, and some may be easily injured. Apply MECTROL brand MCPA Sodium Salt Herbicide only to varieties known to be tolerant to MCPA. If you are uncertain concerning tolerant varieties or local use situations that may affect crop tolerance to MCPA, contact your seed company or state Agricultural Extension Service for advice.

#### THE WEEDS CONTROLLED BY PROPERLY APPLIED TREATMENTS OF MECTROL BRAND MCPA SODIUM SALT HERBICIDE INCLUDE:

common lambsquarters	mustards (except blue mustard)	ragweed
common cocklebur	pepperweeds	(common and giant)
lambsquarters	purslanes	yellow rocket

#### RECOMMENDATIONS FOR APPLYING MECTROL BRAND MCPA SODIUM SALT HERBICIDE

##### Cereal Grains (Not Underseeded With Legumes)

CROP	WEEDS	AMOUNT PER ACRE	DIRECTIONS
Postemergence Wheat, Barley, Oats, and Rye	Annual weeds	1 to 2 Pints*	Apply after grain is in the 4-leaf stage but not forming joints in the stem. <u>Do not spray grain in the boot stage to dough stage.</u>
	Annual and biennial weeds	2 to 4 pints*	Apply after grain is fully tillered (usually about 4 to 8 inches high) but not forming joints in the stem. <u>Do not spray grain in the boot to dough stage.</u>
	Perennial broad-leaf weeds	3 to 4 pints*	
Emergency treatment Wheat	Perennial broad-leaf weeds	6 pints	Apply when weeds are approaching bud stage, <u>but do not spray grain during the boot to dough stage.</u> The 6 pint (1.5 pounds acid equivalent) per acre application can produce injury to wheat. Balance the severity of your weed problem against the possibility of crop damage. Where perennial weeds are scattered, spot treatment is suggested to minimize the extent of crop injury.

##### Cereal Grains (Underseeded With Legumes)

CROP	WEEDS	AMOUNT PER ACRE	DIRECTIONS
Wheat, Barley, Oats and Rye	alfalfa, alsike, red and ladino clovers, trefoil	1/2 to 1 pint	Treat after grain is tillered and is in the 4-leaf stage and when legume seedlings are 2 to 3 inches tall. Small grains should form a protective canopy over the legume seedlings. <u>Do not spray when grain is in the boot to dough stage.</u> Do not use more than 6 gallons of water per acre, higher volumes may result in injury to legumes.

\*Use the lower rate if small annual and biennial weeds are the major problem. Use the higher rate if perennial weeds or annual and biennial weeds are present which are in the hard-to-kill categories as determined by local experience. The higher rates increase the risk of grain injury and should be used only where the weed control problem justifies the risk of grain damage.

MIXING  
INSTRUCTIONS



**RESTRICTIONS AND LIMITATIONS FOR USE ON SMALL GRAINS**

- Use a minimum of 10 gallons of water per acre for ground application and 2 gallons of water per acre for aerial application, unless specific site directions listed above indicate otherwise.
- Do not allow livestock to forage or graze treated areas within 7 days of slaughter.

CROP	AMOUNT PER ACRE	DIRECTIONS
Rice	3 to 5 pints	Treat 7 to 10 weeks after planting when rice is fully tillered and 6 to 8 inches above water. Do not spray after rice has reached the boot stage. Do not spray when temperatures are over 90° F. Use the higher rate where sedges or bulrushes are the major problem. Use the lower rate for control of annual arrowhead, water plantain, and redstem. Use at least 3 to 5 gallons of water per acre for aerial application.

**RESTRICTIONS AND LIMITATIONS FOR USE ON RICE**

- Do not allow livestock animals to forage or graze treated areas within 7 days of slaughter.
- Do not grow crayfish or catfish in treated rice fields.

CROP	AMOUNT PER ACRE	DIRECTIONS
Peas	1/2 to 1 1/2 pint	Treat when peas are 4 to 6 inches tall. Do not spray while peas are in blossom. Peas may show slight injury, but they usually recover a few days after treatment. Use the higher rate before buds form on Canada thistle to prevent from going to seed. Apply in 15 to 30 gallons of water per acre for ground application and 10 gallons of water per acre for aerial application.

**RESTRICTION AND LIMITATIONS FOR USE ON PEAS**

- Do not allow livestock to forage or graze treated fields. Do not feed treated vines to livestock.

**STORAGE AND DISPOSAL**

**STORAGE**

Do not store near fertilizers, seeds, insecticides, or fungicides. Do not contaminate water, food, or feed by storage or disposal.

**PESTICIDE DISPOSAL**

Pesticide wastes are acutely hazardous. Improper disposal of excess pesticide, spray mixture, or rinsate is a violation of Federal Law and may contaminate groundwater. If these wastes cannot be disposed of by use according to label instructions, contact your State Pesticide or Environmental Control Agency, or the Hazardous Waste representative at the nearest EPA Regional Office for guidance.

**CONTAINER DISPOSAL**

Triple rinse (or equivalent). Then offer for recycling or reconditioning, or puncture and dispose of in a sanitary landfill, or by other procedures approved by state and local authorities.

STORAGE AND DISPOSAL

**LIMITED WARRANTY AND DISCLAIMER**

The manufacturer warrants that this product conforms to the chemical description on the label; that this product is reasonably fit for the purposes set forth in the directions for use when it is used in accordance with such directions; and that the directions, warning and other statements on this label are based upon responsible experts' evaluation of reasonable tests of effectiveness, of toxicity to laboratory animals and to plants, and of residues on food crops and upon reports of field experience. Tests have not been made on all varieties or in all states or under all conditions. THE MANUFACTURER NEITHER MAKES NOR INTENDS, NOR DOES IT AUTHORIZE ANY AGENT OR REPRESENTATIVE TO MAKE, ANY OTHER WARRANTIES, EXPRESS OR IMPLIED, AND IT EXPRESSLY EXCLUDES AND DISCLAIMS ALL IMPLIED WARRANTIES OF MERCHANTABILITY OR FITNESS FOR A PARTICULAR PURPOSE. THIS WARRANTY DOES NOT EXTEND TO, AND THE BUYER SHALL BE SOLELY RESPONSIBLE FOR, ANY AND ALL LOSS OR DAMAGE WHICH RESULTS FROM THE USE OF THIS PRODUCT IN ANY MANNER WHICH IS INCONSISTENT WITH THE LABEL DIRECTIONS, WARNINGS OR CAUTIONS.

BUYER'S EXCLUSIVE REMEDY AND MANUFACTURER'S OR SELLER'S EXCLUSIVE LIABILITY FOR ANY AND ALL CLAIMS, LOSSES, DAMAGES OR INJURIES RESULTING FROM THE USE OR HANDLING OF THIS PRODUCT, WHETHER OR NOT BASED IN CONTRACT, NEGLIGENCE, STRICT LIABILITY IN TORT OR OTHERWISE SHALL BE LIMITED, AT THE MANUFACTURER'S OPTION, TO REPLACEMENT OF, OR THE REPAYMENT OF THE PURCHASE PRICE FOR, THE QUANTITY OF PRODUCT WITH RESPECT TO WHICH DAMAGES ARE CLAIMED. IN NO EVENT SHALL MANUFACTURER OR SELLER BE LIABLE FOR SPECIAL, INDIRECT OR CONSEQUENTIAL DAMAGES RESULTING FROM THE USE OR HANDLING OF THIS PRODUCT.

**Notice To Buyer**

Purchase of this material does not confer any rights under patents governing this product or the use thereof in countries outside of the United States.

THIS SPECIMEN LABEL IS INTENDED FOR USE ONLY AS A GUIDE IN PROVIDING GENERAL INFORMATION REGARDING THE DIRECTIONS, WARNINGS AND CAUTIONS ASSOCIATED WITH THE USE OF THIS PRODUCT. AS WITH ANY AGRICULTURAL CHEMICAL, ALWAYS FOLLOW THE LABEL INSTRUCTIONS ON THE PACKAGE BEFORE USING.

Pestex Chemical Co.  
P.O. Box 790  
Waterville, DE 98765

Form No. 93321  
Printed USA - 9/90

MECTROL is a registered trademark of Pestex.  
Made in USA

EPA Approval: 9/21/87

NAME AND ADDRESS OF REGISTRANT

## STUDY QUESTIONS FOR CHAPTER 9

1. Does the label have any legal status?
2. What agency is responsible for approving labels.
3. Must "Keep Out of the Reach of Children" appear on every label?
4. How much flexibility do consultants have in using their previous experience when making recommendations?
5. What does LD<sub>50</sub> mean?
6. What are three "signal" words and how are they related to oral LD<sub>50</sub> values?
7. What signal word is associated with the skull and crossbones?
8. Who may buy a Restricted Pesticide?
9. Does the label of every Restricted Pesticide have the word DANGER on it?
10. Does every label with the word DANGER have a skull and crossbones?
11. What is the legal minimum reentry period if it is not mentioned on the label and not set by the state?



## CHAPTER 10

### AVOIDING CHEMICAL TRESPASS

Chemical trespass means movement of a herbicide to a non-target area after spraying. Probably the most common reason for chemical trespass is spray drift, the lateral movement of the herbicide in spray droplets. Other ways this might happen is through vapor drift, the lateral movement of individual herbicide molecules in the gaseous form, or while attached to soil, distributed either by wind or water.

Chemical trespass is a serious problem because persons responsible for damaging someone else's plants may be faced with litigation, which could turn out to be extremely expensive. In addition, commercial applicators who are judged irresponsible in such cases can even lose their licenses. Also, cases of chemical trespass often become widely publicized, which is very poor public relations for the applicator. If enough such cases become obvious to the public, legislation may even make it more difficult to register new herbicides or to keep the ones we now have. Therefore, doing everything we can to prevent movement of our herbicides to off-target areas becomes highly important.

Because of greater speeds, greater distances above the crop, and turbulences created by aircraft, more drift generally occurs from aerial application than ground application. Fortunately, there are large open areas of the Pacific Northwest in which aerial application can be carried out safely if done carefully. Still, the general principles in reducing drift are especially important with aerial application.

We can't really blame our neighbors if they get upset because our herbicides drift onto

their property. Therefore, all herbicide users must take responsibility for eliminating chemical trespass as a significant problem. How is that done?

1. Low volatile (LV) esters of the phenoxy herbicides are not really low volatile. The high volatile (HV) esters have largely disappeared, although the butyl ester (an HV ester) is used in some areas. Certainly the LV esters are considerably less volatile than the HV ester, but still much more volatile than the amines or metallic salts. Thus, they are more susceptible to movement because gases can move farther with the wind than spray droplets, and vapors can come back off of previously sprayed plants or soil. Choose the amine form of phenoxy herbicides if there are susceptible plants in the area.
2. Even non-volatile chemicals can drift. Especially small spray droplets (or "fines") can move considerable distances in some weather conditions. Tiny droplets can remain suspended in the air for many hours, or even days, by random air movement. Excessive wind at application time is not necessary to keep them suspended. If wind occurs many hours later, these fine droplets can then be carried downwind for long distances, even miles. This probably happens quite frequently, but fortunately, the herbicide becomes diluted as it mixes with the air, and only rarely causes detectable and significant injury if the amount of drifting herbicide is small.

3. Keep spray droplets as large as practical. For most herbicide usage, especially with 2,4-D-type herbicides, a minimum size of 0.2 gal/min (for example, spraying systems 8002) flat fan nozzle tips, and a maximum of 30 psi pressure are sufficient for good coverage. Smaller nozzle tips or higher pressure can produce too many "fines", or small droplets, that can easily move laterally to non-target areas. Some herbicide labels call for application at higher pressure. These products should be applied with extra caution.

Flood-type nozzles can reduce spray drift by producing larger droplets at low pressure. They produce a less precise pattern than flat fan nozzles, but in many situations they are satisfactory. A new generation of flat fan nozzles designed for lower pressure should be considered when the precision of the flat fan is required.

4. A wind screen may reduce drift. A wind screen around the boom and reaching near the sprayed surface may reduce drift. The wind screen should be extended over the top of the boom as well as on the front and back in order to avoid a chimney effect. Sprayers can be equipped with tip monitors to detect plugged nozzle tips, because the spray pattern cannot be seen by the operator.
5. A drift control adjuvant (for example, Nalcotrol) may help reduce the production of small droplets, thereby reducing drift.
6. Proper timing of herbicide application can help avoid damage to nearby plants. For example, grapes are readily injured by 2,4,D-type herbicides (for example, Crossbow). The greatest damage to fruit

production seems to be when drift occurs after the fruiting cluster has emerged but before bloom, generally mid- to late-May. Drift should be avoided at all times, but in areas where grapes are grown, not spraying at all during sensitive stages may be the safest approach. The same principle could be observed with other sensitive plants in the area.

7. Use wide-angle nozzle tips to keep the boom low. Research has indicated that doubling the boom height quadruples drift. Of course, the drift potential from aerial application is considerably higher than from ground application, partly for this reason.
8. The biggest single weather factor involved in drift is wind. Even relatively light breezes can carry small droplets a long way. Generally, spraying early in the morning is preferable to afternoon or evening. Particularly if you are spraying near sensitive crops, limit your applications to when winds do not exceed 5 mph. Spraying when slight winds are away from sensitive crops may be safer than spraying when the air is calm.
9. Consider not spraying those areas nearest to sensitive crops. Leave a buffer zone.
10. Do not apply herbicide to dusty soil that might later be carried on winds to sensitive crops or aquatic areas.
11. Do not apply herbicides to areas where treated soil is likely to be carried by water to where sensitive crops are grown.

Avoiding chemical trespass is the responsibility of each herbicide user. This requires

intelligent management and great care. Pesticide labels include useful information about any special characteristics of the product related to off-target movement.

## STUDY QUESTIONS FOR CHAPTER 10

1. What does chemical trespass mean?
2. Name four ways chemical trespass can occur.
3. Name four reasons why commercial applicators should avoid chemical trespass.
4. Why is drift more likely with aerial application than ground application?
5. Name a high-volatile ester.
6. How does the volatility of a LV ester compare with that of an amine?
7. What are 8 ways to reduce spray or vapor drift?
8. What is a wind screen and how is it used?
9. What is the single biggest weather factor involved in drift?
10. If you are positive that no spray drift occurred, does this guarantee that no chemical trespass can happen? Explain.
11. Would spray drift always occur within 1 hour of application? Explain.

## CHAPTER 11 MANAGEMENT ASPECTS OF HERBICIDE USE

Herbicides are indeed valuable weed control tools, but like all tools, they can be overused, misused, and abused. Because they often are rather powerful tools, the consequences of their misuse sometimes is more severe than misuse of other tools. This chapter deals with a variety of aspects of herbicide management not discussed in previous chapters.

### A. Timing and rates.

A major cause of poor results from herbicides is that they are applied too late. Compounds that would have done an excellent job one month earlier, no longer can be expected to do a satisfactory job. Not uncommonly, in a crop with a number of good herbicides available, there is no good answer when weeds become knee-high. This is largely the grower's responsibility, not the applicator's, but the applicators often are more aware of proper timing than the growers. Reminding the growers of an upcoming problem may be doing him a favor.

Label rates are chosen to give optimum control without crop injury. Label rates are based upon a very large number of experiments over a wide range of conditions. Applying rates above those specified on the label is not only illegal, but may actually do even a poorer job and might injure the crop. An applicator takes considerable risk in applying rates above those on the label. Even if the application is satisfactory and the grower is happy, the applicator can still be held responsible for an illegal treatment. If the grower is

unhappy, the applicator has very little defense in court and runs the possibility of losing both his license and his insurance. As discussed in a previous chapter, with some herbicides, increasing the rate does not necessarily increase effectiveness. It may injure tissue required for translocation and actually reduce eventual control.

### B. Association of herbicides with non-chemical methods (Integrated Weed Management).

Many methods of controlling weeds were carried out for centuries before herbicides appeared. Depending upon the situation, nearly all of those methods can still be valuable today. Herbicides should be looked upon as a component of our weed control system, not the weed control system. Herbicides always work better when used in conjunction with other methods. This concept is commonly referred to as Integrated Weed Management.

With the increasing cost of herbicides, some of the other methods may be cheaper. Timely tillage, flaming, crop rotation, even supplementary hand labor may make good sense. Every experienced applicator knows that results are never as effective when he is called upon to control weeds that have had no other attention besides the herbicide application. Weeds are thick, vigorous, and perhaps too large for adequate control, yet some growers expect applicators to carry a magic wand and the weeds will disappear. Encouraging growers to develop a multi-faceted approach to their weed problems will lead to more consistent



and more complete control by the herbicide application, thus reducing potential problems to the applicators and improving their reputation.

### **C. Weed control in IPM systems.**

In an IPM (Integrated Pest Management) Program, pest management is coordinated with production practices to achieve economical protection from pest injury, while minimizing hazards to crops, human health, and the environment. The emphasis is on anticipating and preventing problems whenever possible by using a variety of methods, and considering the interaction between pests and their control. The term pest can include destructive insects and other arthropods, pathogens, nematodes, weeds, and vertebrates. Specific information concerning the interaction of weeds and their control with other pests is sparse. Documented cases have shown that the presence of uncontrolled weeds might harbor undesirable insects or diseases, thus harming the crop. Weeds can attract pollinators away from the trees in orchards, thus reducing fruit set. On the other hand, weeds have been shown, in some cases, to be beneficial in insect control programs. Weeds can serve as a more desirable source of food for the insects, thus attracting them away from the crop. They might serve as barriers or repellent plants to insects and nematodes. They can harbor desirable insect predators.

In many cases, these relationships are not yet well understood, but herbicide applicators should recognize that weed control does not occur in a vacuum and that controlling weeds

might be either beneficial or detrimental in relation to control of other pests. As more information becomes available in future years, applicators must be responsible for keeping informed and viewing weed control as only one component in a large complex system.

### **D. Development of herbicide-resistant weeds.**

Until recently, weed populations that had developed resistance to herbicides were not a problem. In 1968, a leading U.S. weed scientist said, "Unlike arthropods and microorganisms, higher plants have rarely developed significant resistance to chemicals." That is certainly no longer true. The first case in which large numbers of weed species developed herbicide resistance was with atrazine and simazine. Later, ryegrass, wild oats, and other species developed resistance to Hoelon. Now, weeds are developing resistance to the sulfonyl-urea herbicides, including Glean, Finesse, and Harmony Extra. This is very serious to the growers, because some valuable tools have essentially been lost. Glean and Finesse can no longer be used in fallow fields in Oregon and are no longer sold in some major wheat states, including Montana. Hoelon is ineffective on more than 60 farms in western Oregon. New herbicides are not becoming available fast enough that we can afford to lose the ones we have.

**How do herbicide-resistant weed populations develop?** Most scientists believe that mutations, perhaps over centuries, changed the biochemical nature of certain individual weeds so that they were unaffected when sprayed

many years later with certain herbicides. This may be a very small number, perhaps one resistant plant per million plants of that species. When an effective herbicide is introduced, it may control 999,999 plants out of a million and everyone is pleased. But the one resistant plant survives and produces seed. When the same herbicide is used next year, there may be 50 resistant plants in the field. When the same herbicide is used in following years, control is still excellent for a while, but the number of resistant plants increases each year until the lack of control becomes evident. To make matters worse, in many cases, resistance is genetically dominant, i.e., if a resistant plant and a sensitive plant cross, the offspring will be resistant.

**What can we do about it?** Weeds are not like insects. They are anchored and they don't fly away. We should be intelligent enough to avoid herbicide-resistant weeds. The ways of avoiding resistance have not changed over the years.

1. Use other methods of weed control along with herbicides. This may include cultivating row crops, flaming, delayed seeding to allow mechanical control of the first flush of weeds, drainage, etc.
2. Rotate crops regularly, when possible. Switching from a winter crop to a spring-planted one gives us the opportunity to prepare the land at a different time of the season and perhaps kill the resistant individuals. Or by shifting to another crop, we may use herbicides that the resistant weeds are susceptible to.
3. If crop rotation is not a good option, rotate herbicides annually. To be

effective, the herbicide must be a different type than the one originally used. Weeds resistant to Hoelon also are resistant to Fusilade, Poast, Assure, etc. Glean-resistant weeds also are resistant to Oust, Harmony Extra, and Amber, and often to Arsenal, Pursuit, and Assert.

4. Resist the temptation to use higher rates when weed control starts to decline. The uncontrolled individuals in the population are genetically resistant, and increasing the herbicide dosage will not kill them anyway. It will simply eliminate the less resistant types, leaving the most resistant types to flourish. Using higher than normal rates may actually increase the rate of resistance development.
5. Finish the job if at all possible. Hand weeding on a 5,000-acre wheat ranch is not possible. But in small fields with row crops, this may be extremely cheap in the long term. If a new herbicide provides 99% control the first year, the remaining 1% might just be escapes, but we never know. They might be genetically resistant. Now is the time to eliminate them while they are still few in number.
6. Herbicide combinations are generally used to increase the number of weed species controlled. They will slow the development of resistance only in those weeds that both herbicides affect. The species controlled by only one of the herbicides can develop resistance as rapidly as if that herbicide were used alone. Using two herbicides to control the same weed may not be as wise a use of money as herbicide rotations.

With all of the methods outlined above, it is important that preventative procedures be used before resistance becomes evident. By that time, there will

be large numbers of resistant seeds in the soil, so eliminating all of the resistant type this year may be inadequate. Especially if the seeds are long-lasting, the problem may be with us for many years.

If you are not sure which herbicides are of the same type, check with your local extension agent or herbicide supplier. He/she can find out for you.

## **E. Future developments.**

Predicting the future is always difficult and risky, but it is sometimes fun and costs nothing. Here are some thoughts for consideration, but don't bet the business that they actually will come about.

### **1. New herbicide chemistry.**

Although companies continue to merge and there are fewer companies left, new herbicide chemistry continues to emerge for testing. There likely will be a trend toward less persistent herbicides so that movement into the ground water is less likely. The trend toward lower rates will continue, i.e., ounces per acre rather than pounds per acre.

### **2. The older and less expensive herbicides will disappear.**

The older pesticides are subjected to additional testing in order to meet the more stringent regulations now in place that did not exist when those herbicides were developed. The herbicides are no longer under patent and are almost invariably considerably cheaper than the new ones. In many cases, the manufacturer has very little

incentive to invest millions of dollars in a product when there is little reason to believe that this investment will be repaid. Therefore, the compound ceases to exist and we have lost another tool. Sometimes, the loss of a herbicide leaves a significant gap in our weed control system, making it even more imperative that all available methods be used to keep our weeds under control.

### **3. Herbicide-resistant crops.**

With the expansion of a new science, genetic engineering, horizons in weed science have been expanded. Genes responsible for herbicide resistance in plants can now be transferred into various crops, conferring herbicide resistance. Several crops have been made resistant to glyphosate, for example. Other crops have been engineered to be resistant to other herbicides. This is a slow process, of course, because the new crop must be tested to make sure that it is agronomically or horticulturally superior in other characteristics, such as yield, quality, disease-resistance, etc.

Introducing herbicide-resistant crops may carry with it the risk of unintelligent management. There may be a tendency, as with a new selective herbicide, for growers to use the same herbicide year after year, thus opening greater possibilities for the development of resistant weeds. Good management techniques will be fully as important as with the introduction of a new selective herbicide.

## STUDY QUESTIONS FOR CHAPTER 11

1. What are some consequences of using higher than label rates.
2. Discuss the value of encouraging growers to apply herbicides at the optimum time.
3. Discuss the value of encouraging growers to use non-chemical methods along with herbicides.
4. What does Integrated Weed Management mean?
5. What do the letters IPM mean?
6. Is the presence of weeds beneficial or detrimental in the control of other pests?
7. How do herbicide-resistant weed populations develop?
8. Name five ways to slow or avoid developing herbicide-resistant weeds.
9. What impact does increasing herbicide rate have on developing herbicide-resistant weeds?
10. Will switching from one herbicide to another always reduce development of herbicide resistance? Why or why not?



## CHAPTER 12 GLOSSARY

- **Absorption** - Movement from the surface into a body as the process by which herbicides are taken into plants, by roots or foliage (stomata, cuticle, etc.).
- **Acid Equivalent** - The theoretical yield of parent acid from an active ingredient.
- **Active Ingredient** - The chemicals in a product that are responsible for the herbicidal effects.
- **Acute Effect** - Rapid and severe (opposed to chronic).
- **Adaptive Microbial Breakdown** - The type of degradation of a substance, such as a herbicide, resulting from a buildup of certain microorganisms that benefit from the presence of the substance.
- **Adjuvant** - A substance added to a prescription to aid in the operation of the main ingredient. An additive.
- **Adsorption** - Chemical and/or physical attraction of a substance to a surface. Can refer to gases, dissolved substances, or liquids on the surface of solids or liquids.
- **Allelopathy** - Harmful effect of one plant on another through the production of chemical compounds.
- **Amine** - A class of compound derived from ammonia by replacing the hydrogens with organic radicals.
- **Annual** - A plant that completes its life cycle in one year. A summer annual germinates from seed in the spring, produces seed and dies in the same season. Examples: pigweed, ragweed, foxtail, crabgrass. A winter annual is one which germinates in the fall, lives over winter, then flowers and seeds the following spring and summer, such as pennyroyal, hedge mustard, and peppergrass. Also see Winter Annual.
- **Apoplast** - Refers to an interconnected network of non-living tissues in the plants. Includes the xylem and secondary cell walls.
- **Aquatic** - A plant that grows in water. There are three kinds: Submergent - which grows beneath the surface; Emergent - which root below but extend above the water, such as cattails and water lilies; Floater - such as water hyacinth.
- **Aromatics** - Compounds derived from the hydrocarbon benzene ( $C_6H_6$ ).
- **Band Application** - An application to a continuous restricted band such as in or along a crop row, rather than over the entire field area.
- **Basal Treatment** - Herbicide treatment applied to the stems of woody plants at and just above the ground.
- **Bed** - (1) A narrow flat-topped ridge on which crops are grown with a furrow on each side for drainage of excess water. (2) An area in which seedlings or sprouts are grown before transplanting.

- **Bed-up** - To build up beds or ridges with a tillage implement.
- **Beta Oxidation** - Metabolic process in which organic acids are shortened by 2-carbon increments. 2,4-DB is converted to 2,4-D by beta oxidation. Fatty acids are also metabolized in plants and animals by beta oxidation.
- **Biennial** - A plant that completes its growth in two years. The first year it produces leaves and stores food; the second year it produces fruits and seeds.
- **Bioassay** - A test method using living organisms to determine the presence of a chemical.
- **Blind Cultivation** - Cultivating after the crop is planted but before it emerges.
- **Boot Stage** - The growth stage in grass in which the inflorescence expands the upper leaf sheath. Head is swollen but not yet visible.
- **Broadcast (blanket) Application** - An application of spray or dust over an entire area rather than only on rows, beds, or middles.
- **Brush Control** - Control of woody plants.
- **Carrier** - The liquid or solid material added to a chemical compound to facilitate its application.
- **Chemical Trespass** - The movement of a chemical to an area other than the target site; it can occur in wind, water, or soil.
- **Chlorosis** - Loss of green color in foliage.
- **Chronic** - Slow and long continued effect.
- **Compatible** - Quality of two compounds that permits them to be mixed without effect on the properties of either.
- **Competition** - The struggle for limited resources among plants within the same habitat. Plants can compete for light, water, nutrients, and perhaps other resources such as CO<sub>2</sub> and space.
- **Concentration** - The amount of active material in a given volume of diluent. Recommendations and specifications for concentration of herbicides should be on the basis of pounds or kilograms per unit volume of diluent.
- **Contact Herbicide** - A herbicide that kills primarily by contact with plant tissue rather than as a result of translocation.
- **Cotyledon Leaves** - The first leaf, or pair of leaves, of the embryo of seed plants.
- **Crook Stage** - After bean seedling has broken through the soil and before the stem has become erect.
- **Crown** - The base of the stem where roots arise.
- **Deciduous** - Indicates plants which lose their leaves during the winter.

- **Defoliator or Defoliant** - A compound which causes the leaves or foliage to drop from the plant.
- **Delayed Cultivation or Delayed Tillage** - Process of waiting past the normal planting date to allow weeds to germinate, then using tillage to kill the weeds before planting the crop.
- **Desiccant** - A compound that promotes dehydration of plant tissue.
- **Diluent** - Any liquid or solid material serving to dilute an active ingredient in the preparation of a formulation.
- **Directed Spray** - An application made to minimize the amount of herbicide applied to the crop. This is usually accomplished by setting nozzles low with spray patterns intersecting at the base of the plants just above the soil line.
- **Dormant** - State of inhibited growth of seeds or other living plant organs due to internal causes. Dormant seeds fail to germinate even when they are placed in good germination conditions.
- **Ecological Niche** - A microhabitat that may be suited for support of an individual organism. A species' "place" within a community; i.e., its place in space, time, or function within that community.
- **Economic Injury Level** - Pest populations sufficient to cause damage values at the cost of practical control.
- **Emergence** - Appearance of the first part of the crop plant through the ground.
- **Emulsifying Agent** - A material which facilitates the suspending of one liquid in another.
- **Emulsion** - A mixture in which one liquid is suspended in minute globules in another liquid; for example, oil in water.
- **Epinasty** - Increased growth on the upper surface of a plant organ or part (especially leaves) causing it to bend downward.
- **Flag Stage** - The early postemergence stage of onion seedlings between the "crook" stage and the emergence of the first true leaf. The bent tip of the seed leaf resembles a flag attached to a staff. Also referred to as the "knee" stage.
- **Formulation (of herbicides)** - The way in which basic herbicidal chemicals are prepared for practical use. Includes preparation as wettable powders, granulars, emulsifiable concentrates, etc.
- **Fumigant** - Chemical used in the form of a volatile liquid or a gas to kill insects, nematodes, fungi, bacteria, seeds, roots, rhizomes, or entire plants; usually applied in an enclosure of some kind or in the soil.
- **Growth Regulator** - An organic substance effective in minute amounts for controlling or modifying plant processes.
- **Growth Stages of Cereal Crops** - (1) Tillering stage - when additional shoots are developing from the crown; (2) jointing stage - when stem internodes begin elongating and first



stem node becomes visible above ground; (3) boot stage - when leaf sheath swells due to the growth of developing spike or panicle; (4) heading stage - when seed head is emerging from the sheath.

- **Hard Water** - Water which contains certain minerals, usually calcium and magnesium sulfates, chlorides, or carbonates, in solution, to the extent of causing a curd, or precipitate, rather than a lather, when soap is added. Very hard waters may cause objectional precipitates to form in some herbicidal sprays.
- **Hazard** - See Risk.
- **Herbaceous Plant** - A vascular plant that does not develop woody tissue.
- **Herbicide** - A chemical used for killing or inhibiting the growth of plants.
- **Hill Reaction** - Process of photosynthesis in which light energy is used to "split" water molecules, resulting in oxygen, H<sup>+</sup> ions, and electrons. This process is inhibited by certain herbicides such as ureas, triazines, and uracils.
- **Hormone** - A growth-regulating substance occurring naturally in plants or animals. Also refers to certain man-made or synthetic chemicals with growth-regulating activity. However, these are more correctly called synthetic regulators; they are not hormones.
- **Incidental Microbial Breakdown** - The type of degradation of a substance, such as a herbicide, resulting from the substance "getting in the way" of microbes. The microbes can degrade

the substance, but they do not seem to benefit from it, and they do not increase in population as a result of the presence of the substance.

- **Inert Ingredient** - Any ingredient in a formulation with no pesticidal action.
- **Integrated Pest Management (IPM)** - The concept of managing the crop and its pests as a system, considering that control measures for one pest may affect another.
- **Integrated Weed Management** - The concept of selecting from all available weed control methods, including chemical or non-chemical methods.
- **Intercropping** - See Multiple Cropping.
- **Interference** - The detrimental effect of one plant on another. May include both competition and allelopathy.
- **Invert Emulsion** - One in which the water is dispersed in oil rather than oil in water. Oil forms the continuous phase with the water dispersed therein. Usually a thick mayonnaise-like mixture results.
- **Jointing Stage** - Growth stage of grasses which begins when the first node of the stem is visible at the base of the shoot.
- **Lag Phase** - (See Adaptive Microbial Breakdown) - The period of time during which adaptive microbes are increasing in population. Very little breakdown occurs during the lag phase, but subsequent breakdown is rapid because of the population increase of the microbe.

- **Lay-by** - Refers to the stage of crop development (or the time) when the last regular cultivation is done.
- **LD<sub>50</sub>** - Lethal Dose<sub>50</sub> - Amount of toxicant required to kill 50% of the test species.
- **Leach** - Usually refers to movement of water through a soil, which may move soluble plant foods or other chemicals.
- **Miscible Liquids** - Two or more liquids capable of being mixed and will remain mixed under normal conditions.
- **Multiple Cropping** - The practice of growing more than one crop on a piece of land within a given year. May consist of one or more of the following:
  - intercropping:** Growing two or more crops at the same time through most or all of their life cycles.
  - relay cropping:** Planting one crop before another crop on the same land is harvested. Their life cycles overlap.
  - sequential cropping:** Planting one crop after another crop on the same land is harvested.
- **Necrosis** - The death of tissue (such as all or part of a plant).
- **Niche** - See Ecological Niche.
- **Non-selective Herbicide** - A herbicide that can be used to kill plants generally without regard to species.
- **Noxious Weed** - A plant arbitrarily

defined by law as being especially undesirable, troublesome, and difficult to control. Definition of the term "noxious weed" will vary according to legal interpretations.

- **Perennial** - A plant that continues to live from year to year. In many cases, in cold climates, the stem dies down but the root persists.
  - **simple perennial:** A perennial that spreads by seeds or a piece of vegetative propagule. Little or no lateral spread in an undisturbed situation.
  - **creeping perennial:** A perennial that spreads laterally by stolons, rhizomes, or roots.
- **Pesticide** -- Any substance or mixture of substances intended for controlling insects, rodents, fungi, weeds, and other forms of plant or animal life that are considered to be pests.
- **Phloem** - The principal food-conducting tissue of vascular plants.
- **Phytobland** - Not toxic to plants.
- **Phytotoxic** - Poisonous to plants.
- **Postemergence** - After emergence of specified weed or crop above the soil.
- **Preemergence Treatment** - Treatment made after a crop is planted but before it emerges.
- **Preplanting Treatment** - Treatment made before the crop is planted.
- **Rate and Dosage** - These terms are synonymous. "Rate" is the preferred

term. Usually refers to the amount of active ingredient of material (such as 2,4-D acid equivalent) applied to a unit area (such as one acre) regardless of percentage of chemical in the carrier.

- **Relay Cropping** - See Multiple Cropping.
- **Residual** - To have a continued killing effect over a period of time.
- **Residue Tolerance** - The amount of chemical pesticide residue that may legally remain in or on a crop or commodity at the time of its sale or use.
- **Resistant** - Same general meaning as tolerant except usually refers to a high degree of tolerance. Resistance of weeds determines the rates of weed killer application required for control.
- **Rhizome** - Underground stem capable of sending out roots and leafy shoots.
- **Risk** - Chance of danger or harm. Depends on both toxicity and chance of exposure.
- **Rosette** - A circular cluster of leaves; usually the stage in biennials before a flower stalk is sent up.
- **Safe** - Acceptably free from hazard. Based on a personal decision that a risk is acceptable.
- **Scarification** - Process of scarring a seedcoat to make it more permeable to water.
- **Selective Herbicide** - A compound that is more toxic to the weeds than to the crop in the field. Helps control weeds

without damaging the crops.

- **Sequential Cropping** - See Multiple Cropping.
- **Sink** - Refers to a site within a plant at which a high rate of metabolic activity is taking place and food materials are being used up or stored. In the case of several herbicides, including 2,4-D, the herbicide is transported along the translocating food material and tends to be directed toward these "sinks".
- **Slurry** - A highly concentrated mixture of the carrier (generally water) and the herbicide. This is used to help disperse the herbicide formulation, usually wettable powders, before adding to the spray tank.
- **Soil Application** - Application of chemical made primarily to the soil surface rather than to vegetation.
- **Soil Enrichment (microbiological)** - A build-up of a particular group of microbes in the soil that are well-adapted to breaking down a particular herbicide.
- **Soil Incorporation** - Mechanical mixing of the herbicide with the soil.
- **Soil Injection** - Mechanical placement of the herbicide.
- **Soil Persistence** - Refers to the length of time that a herbicide application on or in soil remains effective.
- **Soil Sterilant** - A herbicide that prevents the growth of plants when present in the soil. Soil sterilization effects may be temporary or relatively long-term.

- **Spike Stage** - The very early emergence stage of grasses, including corn, in which the leaves are still tightly rolled to form a "spike". Usually before the corn is more than two inches tall.
- **Spot Treatment** - Application of sprays to localized or restricted areas as differentiated from overall, broadcast, or complete coverage.
- **Spray Drift** - The movement of air-borne spray particles from the spray nozzle beyond the intended contact area.
- **Starvation Test** - Process of exposing a proposed biological control agent to important plant species other than the weed for which it is being imported. It must starve in order to be considered for release.
- **Stolon** - Runners or stems that develop roots and shoots at the tip or nodes, as in the strawberry plant.
- **Stool** - To throw out shoots, to tiller.
- **Stunting** - In relation to weeds or crop plants, usually refers to a retarding effect on growth and development. Often stunting of weeds or grasses, even without kill, may give effective commercial control.
- **Summer Annual** - A plant that germinates from seed in the spring, lives over the summer, and sets seed and dies in late summer or fall. Examples are lambsquarters, Russian thistle, and barnyardgrass.
- **Surface Tension** - A physical property of liquids, due to molecular forces, that causes them to form drops rather than spread as a film.
- **Surfactant** - A type of adjuvant that in pesticide formulations imparts emulsifiability, spreading, wetting, dispersibility or other surface-modifying properties. A surface-active agent.
- **Suspension** - A liquid or gas in which very fine solid particles are dispersed, but not dissolved.
- **Symplast** - Refers to an interconnected system of the living tissues within a plant. Includes the phloem and other living cells.
- **Synergism** - Cooperative action of different chemicals such that the total effect is greater than the sum of the independent effects.
- **Systemic Herbicide** - A compound that is translocated within the plant and has an effect throughout the entire plant system.
- **Tillering** - Formation of erect shoots or tillers from the crown of a grass. Also called "stooling".
- **Tolerance (pesticide)** - The amount of pesticide chemical allowed by law to be in or on the plant or animal product at the time of sale or use.
- **Tolerant** - Capable of withstanding effects. For example, grass is tolerant of 2,4-D to the extent that this herbicide can be used selectively to control broadleaf weeds without killing the grass.

- **Toxicity** - "How poisonous is it". The ability of a chemical to cause harm if exposure occurs. Depends on rate.
  - **USR** - Unsulfonated Residue. This is a chemical test for degree of unsaturation (double and triple bonds) in an oil. The more unsaturation (therefore more phytotoxic), the lower the USR number. A phytobland oil has a high USR number (90 or so) and a phytotoxic oil has a low USR (15 or so).
  - **Vapor Drift** - The movement of vapors from the area of application to other areas.
  - **Vascular Tissue** - A general term referring to either or both xylem and phloem.
  - **Volatile** - A compound is volatile when it evaporates, or vaporizes (changes from a liquid to a gas), at ordinary temperatures on exposure to air.
  - **Weed** - A plant growing where it is not desired; a plant with a negative value.
  - **Weed Control** - The process of limiting weed infestations so that crops can be grown profitably or other operations can be conducted efficiently.
  - **Weed Eradication** - The complete elimination of all live plants, plant parts, and seeds of a weed infestation from an area.
  - **Wetable Powder** - A powder that will readily form a suspension in water.
  - **Wetting Agent** - A compound that, when added to a spray solution, causes
  - **Translocation** - Transfer of food or other materials, such as herbicides, from one plant part to another.
- it to contact plant surfaces more thoroughly.
- **Winter Annual** - A plant that starts germination in the fall, lives over winter, and completes its growth, including seed production, the following season. (Examples: chickweed, downy brome). Many plants commonly known as annuals can also be classified as winter annuals, depending on the time of germination, etc. (Also see **Annual**.)
  - **Xylem** - The principal water-conducting tissue in vascular plants; it is non-living in mature plants.

## APPENDIX I

### Herbicides Alphabetically by Common Name

<u>Common name</u>	<u>Trade Name</u>	<u>Common name</u>	<u>Trade Name</u>
alachlor	Lasso	metolachlor	Dual
ametryne	Evik	metribuzin	Sencor, Lexone
amitrole	Cytrol, Amitrole-T	metsulfuron	Ally, Escort
atrazine	Aatrex, others	napropamide	Devrinol
benefin	Balan	nicosulfuron	Accent
bensulfuron	Londax	oryzalin	Surflan
bentazon	Basagran	oxadiazon	Ronstar
bromacil	Hyvar X	paraquat	Gramoxone
bromoxynil	Buctril	pendimethalin	Prowl
butylate	Sutan	picloram	Tordon
chlorimuron	Classic	primisulfuron	Beacon
chlorsulfuron	Glean, Telar	prometone	Pramitol
clopyralid	Stinger	prometryne	Caparol
cyanazine	Bladex	pronamide	Kerb
cycloate	Ro-Neet	sethoxydim	Poast
dicamba	Banvel	siduron	Tupersan
dichlorprop	(2,4-DP)	simazine	Princep
diclofop	Hoelon	sulfometuron	Oust
difenzoquat	Avenge	terbacil	Sinbar
diquat	Reglone	thifensulfuron	Pinnacle, Harmony
diuron	Karmex, others	trallate	Fargo
EPTC	Eptam, Eradicane	triasulfuron	Amber
ethalfluralin	Sonalan	tribenuron	Express
ethametsulfuron	Muster	triclopyr	Garlon
fencxaprop	Tiller, Horizon, others	trifluralin	Treflan
fluazifop	Fusilade	2,4-D	many
glyphosate	Roundup, others	2,4-DB	Butoxone
linuron	Lorox	vernolate	Vernam
mecoprop	(MCP)		

## APPENDIX II

### Herbicides Alphabetically by Trade Name

<u>Trade name</u>	<u>Common Name</u>	<u>Trade name</u>	<u>Common Name</u>
Aatrex	atrazine	Hyvar X	bromacil
Accent	nicosulfuron	Karmex	diuron
Ally	metsulfuron	Kerb	pronamide
Amber	triasulfuron	Lasso	alachlor
Amitrol-T	amitrole	Lexone	metribuzin
Avenge	difenzoquat	Londax	bensulfuron
Balan	benefin	Lorox	linuron
Banvel	dicamba	(MCPP)	mecoprop
Basagran	bentazon	Muster	ethametsulfuron
Beacon	primisulfuron	Oust	sulfometuron
Bladex	cyanazine	Pinnacle	thifensulfuron
Buctril	bromoxynil	Poast	sethoxydim
Butoxone	2,4-DB	Pramitol	prometone
Caparol	prometryne	Princep	simazine
Classic	chlorimuron	Prowl	pendimethalin
Cytrol	amitrole	Reglone	diquat
Devrinol	napropamide	Ro-Neet	cycloate
Dual	metolachlor	Ronstar	oxadiazon
Eptam	EPTC	Roundup	glyphosate
Eradicane	EPTC	Sencor	metribuzin
Escort	metsulfuron	Sinbar	terbacil
Evik	ametryne	Sonalan	ethalfuralin
Express	tribenuron	Stinger	clopyralid
Fargo	triallate	Surflan	oryzalin
Fusilade	fluazifop	Sutan	butylate
Garlon	triclopyr	Telar	chlorsulfuron
Glean	chlorsulfuron	Tiller	fenoxaprop
Gramoxone	paraquat	Tordon	picloram
Harmony	thifensulfuron	Tupersan	siduron
Hoelon	diclofop	(2,4-DP)	dichlorprop
Horizon	fenoxaprop	Vernam	vernolate

## ANSWERS TO STUDY QUESTIONS

### CHAPTER 1

1. A circular cluster of leaves; early emergence stage of grasses in which the coleoptile has emerged; onion seedlings between the "crook" and the emergence of the first true leaf; formation of erect shoots from the crown of a grass: when the first node of the stem appears above-ground.
2. Plants whose negative characteristics outweigh its positive characteristics. These characteristics are judged differently by different people.
3. Erosion control, recycling nutrients, gene pool, esthetics, wildlife cover. Competition for resources, product contamination, harboring other pests, clogging irrigation channels, poisoning livestock.
4. Summer annuals germinate in the spring and die at the end of the summer; winter annuals germinate in the fall and die in the spring. Crabgrass, barnyardgrass, nightshade. Cheat, henbit, fiddleneck.
5. Plant with a 2-year cycle. Tansy ragwort, wild carrot.
6. In an undisturbed state, seeds only. Can spread by vegetative pieces distributed by man or animals.
7. Seed, bulbs, rhizomes, stolons, lateral roots. Yes.
8. Broadleaves have two leaves as they emerge from the seed, true leaves generally broad with net-like veins. Grasses have one leaf as they emerge and true leaves are narrow with parallel veins.
9. Triangular stems and three rows of leaves.
10. Parasitic weed.
11. A biennial should be sprayed at the seedling or rosette stage, never after the seedstock starts to form. A creeping perennial at the bud to early bloom or on regrowth in the fall.
12. After fully tillered and before the jointing stage.

### CHAPTER 2

1. Substance added to a pesticide mixture to help the main ingredient do a better job.
2. A surfactant is a particular type of adjuvant.
3. One end of a surfactant is lipophilic and the other end is hydrophilic.
4. Anionic, cationic, nonionic. Anionic can form insoluble precipitates in hard water. Nonionics are easy to use, non-toxic, and not affected by hard water. Cationic ionizes to form a positively charged hydrophilic part. The non-ionic type is most often used with herbicides.
5. Generally, yes.
6. May reduce selectivity and needlessly costs extra money if the weed is easily wet without it.
7. Non-toxic to plants.
8. Unulfonatable residue. The USR indicates the potential toxicity to plants,



low USR being phytotoxic, high being phytobland.

9. By reducing the number of fine droplets.
10. Wetting agents, drift retardants, oils, buffering agents, foaming agents, anti-foaming agents, odor inhibitors, stenching agents, and emetics.
11. An additive that induces vomiting.
12. Crops in the carrot family.
13. An adjuvant used to adjust the acidity of the spray solution.

### **CHAPTER 3**

1. Preparing a product for practical use.
2. Soluble concentrates, emulsifiable concentrates, wettable powders, dry flowable (dispersable granules and dry flowables), flowables.
3. Granules and pellets.
4. See text.
5. There is no difference.
6. These formulations all act exactly the same as suspensions in the water.
7. To reduce drift.
8. Active ingredient is the entire active molecule, acid equivalent is only the acid part without the salt or ester part. The active ingredient percentage is always higher.
9. Always add a wettable powder first and get it distributed before adding an EC.

10. Use the jar method.

### **CHAPTER 4**

1. In the sugar flow.
2. Broadleaves and certain non-grass monocots.
3. Growth regulator.
4. Because it is long-lived in the soil and highly toxic to many types of plants.
5. Moderate.
6. Growth regulators.
7. Inactive.
8. Among the most toxic herbicides.
9. Grasses.
10. Hoelon (diclofop), Poast (sethoxydim), and Horizon or Tiller (fenoxaprop).
11. Most are short-lived in the soil.
12. Very low in toxicity.
13. Primarily in the sugar flow.
14. Inactive.
15. By inhibiting photosynthesis.
16. Very low mammalian toxicity.
17. Entirely in the water stream.
18. See discussion in the text.

19. To prevent rapid evaporation from the soil surface.
20. a. Sulfonylurea. b. Growth-regulator. c. Thiocarbamate. d. Triazine. e. FAS inhibitor. f. Sulfonylurea. g. Dinitroaniline. h. Urea. i. Uracil. j. Growth-regulator. k. Growth-regulator. l. FAS inhibitor.

## **CHAPTER 5**

1. Volatilization of the material before it reaches the plant, spray drift, canopy effect.
2. Retention would be much greater with wild mustard.
3. High humidity increases the time required for the droplet to evaporate and components within the cuticle can absorb water and swell, making the pathway for the herbicide easier.
4. The pathway of uptake for water-soluble herbicides depends more on water than the oil-soluble herbicides.
5. Good soil moisture is required to prevent wilting and shrinking of the cuticle layer.
6. Plants grown under hot, dry conditions have a thicker cuticle.
7. The sugar stream and the water stream.
8. At the bud to early bloom stage and in the fall before a killing frost.
9. Movement of sugar from where they are formed (leaves) to where they are being used up.
10. Buds, newly forming leaves, root tips,

storage organs.

11. 2,4-D, MCPA, 2,4-DB, atrazine, diuron, Sinbar (terbacil). Glean (chlorsulfuron), Tordon (picloram), Poast (sethoxydim).
12. Living tissue required for translocation of the herbicide may be damaged, thus inhibiting further translocation.

## **CHAPTER 6**

1. Temperature, moisture, aeration, organic matter content, pH. The most important are temperature and moisture.
2. In adaptive, a micro-population builds up that is adapted to breaking the herbicide down. In incidental action, the microbes degrade the herbicide, but derive no benefit from it and do not build up.
3. The buildup of an adapted soil microbe population capable of breaking the herbicide down.
4. The period of time required for the population to become adapted and to build up prior to the rapid decline of herbicide concentration.
5. Glean is hydrolyzed more quickly at low pH levels than at high pH.
6. Chemical and/or physical attraction of a substance to a surface. A herbicide that is adsorbed is unavailable for uptake by plants, so a higher rate is required in adsorptive soils.
7. Texture, type of clay, organic matter content, and moisture.

8. Water can compete with a herbicide for adsorption sites in the soil, so adsorption is less on moist soil than dry soils. Volatile herbicides are not be as adsorbed in moist soil and are more likely to evaporate from wet soils.
9. Downward movement of a substance in solution through the soil.
10. Degradation of a herbicide from absorption of light energy. Trifluralin, paraquat, Devrinol, and to a less extent, diuron. Devrinol napropamide is influenced most.
11. Soil moisture.

## **CHAPTER 7**

1. Cheap, easily obtained, strong. But susceptible to rust and corrosion.
2. Stainless steel, plastic-coated steel, plastic reinforced with fiberglass, aluminum alloys.
3. No agitation required beyond initial mixing. Mechanical agitation is required for wettable powders. Bypass hydraulic agitation is sufficient for emulsions.
4. Use a 50-mesh strainer for wettable powders, a 100-mesh strainer for soluble materials.
5. 50 openings per linear inch.
6. Gear pump, roller pump, piston pump, and diaphragm pump. See text for advantages and disadvantages.
7. Centrifugal pump. See text.
8. Nozzles that are suspended below the boom to apply herbicides beneath the crop canopy. They are used to obtain greater coverage of small weeds and to reduce injury to the crop.
9. To spray a strip through the field, generally over the row without spraying between the rows. It is used in row crops and orchards. For normal band spraying, an even spray flat fan nozzle is used.
10. Aluminum, brass, ceramic, plastic, stainless steel, hardened stainless steel. Brass and aluminum are cheapest. Ceramic, plastic, and stainless steel are most corrosion and abrasion resistant.
11. Lower the boom.
12. Regular flat fan produces less spray at the edges of the pattern and is designed for overlap. Even spray produces the same amount of spray across the entire band and is not designed for overlap.
13. Double overlap, spraying twice at right angles, "lapping half".
14. Using the type of nozzle screen with a check valve.
15. At a slight angle to the boom so that the pattern from adjacent nozzles do interfere.
16. Increasing orifice size decreases drift.
17. Compressed air or a brush with soft bristles.
18. See text for list of procedures.

## CHAPTER 8

1. Measuring the output of an applicator for a given area in order to apply the desired rate of a herbicide.
2. Nozzle tips, pump, all connections.
3. Spraying a swath across dark pavement or dry soil and watching the pattern dry.
4. Double the speed.
5. Quadruple.
6. Change nozzle tips. Change speed.
7.  $1000 \times 523 = 523,000$  sq ft.  
43,560 sq ft in acre.  
 $\frac{523,000}{43,560} = 12$  acres
8.  $\frac{.31 \text{ gal} \times 20 \text{ nozzles}}{20 \text{ nozzles } 1.5 \text{ ft} \times 300 \text{ ft}} = \frac{X \text{ gpa}}{43,560 \text{ sq ft}}$   
 $\frac{6.2 \text{ gal}}{9,000 \text{ sq ft}} = \frac{X \text{ gal}}{43,560 \text{ sq ft}}$   
 $X = 30 \text{ gal/acre}$
9.  $\frac{300 \text{ gal/tank}}{30 \text{ gal/acre}} = 10$  acres per tankful
10. Each tankful sprays 10 acres.  
Rate = 3 lb active ingredient per acre  
Add 30 lbs active per tankful.
11.  $\frac{30 \text{ lb active}}{80\%} = 37.5$  lbs W.P. per tankful  
  
(NOTE: Divide by the percentage , don't multiply)
12.  $\frac{30 \text{ lb active}}{4 \text{ lb ai/gal}} = 7.5$  gallons per tankful

## CHAPTER 9

1. Yes, the label is a legal document. Usage of the product in a way other than the directions on the label is illegal.
2. EPA.
3. Yes.
4. Recommending the usage of a pesticide in ways other than is directed on the label is illegal and subject to fines, regardless of how safe or effective it may be when used otherwise.
5. LD<sub>50</sub> means lethal dose 50, the amount of pesticide required to kill 50% of the test animals. Usual units are milligrams per kilogram of body weight. The lower the LD<sub>50</sub>, the higher the toxicity.
6. DANGER (oral LD<sub>50</sub> = 1-50), WARNING (oral LD<sub>50</sub> = 50-500), CAUTION (oral LD<sub>50</sub> = 500-5,000).
7. DANGER.
8. Only certified applicators. This may include private applicators, commercial applicators and certified governmental applicators (in the specific crop and usage in which they have been certified), and consultants.
9. No. A pesticide may be restricted, not because of mammalian toxicity, but because of soil persistence and high activity on many plants, or because of some questions involved in cancer-causing properties.
10. No. The word DANGER may be applied because of a hazard from corrosive

damage to the skin or eyes (see sample MECTROL label).

11. Until sprays have dried and dusts have settled.

## **CHAPTER 10**

1. Movement of a herbicide to a non-target area after spraying.
2. Spray drift, vapor drift, movement of treated soil by wind, movement of treated soil by water.
3. An applicator can be faced with a lawsuit, may lose his license, may damage his reputation and thus his business, or it may lead to legislation adverse to herbicide use.
4. Greater speed, greater distance above the crop, and turbulence created by aircraft.
5. Butyl-ester.
6. An LV-ester is considerably more volatile than an amine.
7. Use wider angle nozzle tips and thus lower the boom, use larger nozzle orifices, lower spray pressure, avoid spraying in the wind, use drift adjuvants, use a windscreen, use amine forms rather than ester forms, use floodjet nozzle tips.
8. A screen or drape, generally on the front, back, and top of a boom, to keep spray droplets from drifting off target.
9. Wind.
10. No. Chemical trespass can still occur by volatilization of the herbicide from treated leaves and soil, movement of treated soil

by wind, movement of treated soil by water.

11. No. If the spray application produced many "fines", they can remain suspended for many hours and later be moved by wind to non-target areas.

## **CHAPTER 11**

1. The applicator may be sued, lose his license, lose his insurance, and reduce the performance of the herbicide.
2. Applications of herbicides at the optimum time will improve the performance of the herbicide, which is good for the applicator and his reputation.
3. Herbicides always work best when used in conjunction with other methods. Therefore, the applicator does a better job, the grower is grateful, and the applicator's business and reputation improves.
4. The use of a variety of available methods for controlling weeds. It can include both chemical and non-chemical methods.
5. Integrated Pest Management.
6. Weeds can help prevent pest damage by attracting insects or nematodes away from the crop or by repelling them from the area. They can also harbor beneficial predator insects. But they can attract and harbor harmful pests, which then can increase damage to the crop.
7. See discussion in the text.
8. Use non-chemical methods, rotate crops, rotate herbicides, finish the job if possible, use herbicide combinations.

9. Increasing herbicide rate may actually increase the rate of developing herbicide-resistance.
  
10. Switching from one herbicide to the next will only be effective in slowing herbicide resistance if the herbicides are of a different type. Switching from one member of the same family to another will not help. Also, annual herbicide rotation will not absolutely prevent herbicide resistance, because seeds from resistant types can emerge for more than one year and can build up the population during the years a particular herbicide is used.







